

## Information

# MINIATURE SIGNAL RELAYS

**ED2 SERIES (DIP TYPE)**

**EF2 SERIES (SMD TYPE)**

**TECHNICAL DATA**

---

© EM Devices Corporation 2018



- All specifications in this catalog and production status of products are subject to change without notice. Prior to the purchase, please contact EM Devices for updated product data.
- Please request for a specification sheet for detailed product data prior to the purchase.
- Before using the product in this catalog, please read "Precautions" and other safety precautions listed in the printed version catalog.

[MEMO]



- All specifications in this catalog and production status of products are subject to change without notice. Prior to the purchase, please contact EM Devices for updated product data.
- Please request for a specification sheet for detailed product data prior to the purchase.
- Before using the product in this catalog, please read "Precautions" and other safety precautions listed in the printed version catalog.

The information in this document is based on documents issued in April, 2019 at the latest.

The information is subject to change without notice. For actual design-in refer to the latest publications of data sheet, etc., for the most up-date specifications of the device.

No part of this document may be copied or reproduced in any form or by any means without the prior written consent of EM Devices Corporation. EM Devices Corporation assumes no responsibility for any errors which may appear in this document.

EM Devices Corporation does not assume any liability for infringement of patents, copyrights or other intellectual property rights of third parties by or arising from use of a device described herein or any other liability arising from use of such device. No license, either express, implied or otherwise, is granted under any patents, copyrights or other intellectual property rights of EM Devices Corporation or others.

While EM Devices Corporation has been making continuous effort to enhance the reliability of its electronic components, the possibility of defects cannot be eliminated entirely. To minimize risks of damage or injury to persons or property arising from a defect in an EM Devices electronic component, customers must incorporate sufficient safety measures in its design, such as redundancy, fire-containment, and anti-failure features. EM Devices' products are classified into the following three quality grades:

"Standard," "Special," and "Specific". The Specific quality grade applies only to devices developed based on a customer designated "Quality assurance program" for a specific application. The recommended applications of a device depend on its quality grade, as indicated below. Customers must check the quality grade of each device before using it in a particular application.

- Standard: Computers, office equipment, communications equipment, test and measurement equipment, audio and visual equipment, home electronic appliances, machine tools, personal electronic equipment and industrial robots
- Special: Transportation equipment (automobiles, trains, ships, etc.), traffic control systems, anti-disaster systems, anti-crime systems, safety equipment and medical equipment (not specifically designed for life support)
- Specific: Aircrafts, aerospace equipment, submersible repeaters, nuclear reactor control systems, life support systems or medical equipment for life support, etc.

The quality grade of EM Devices' products are "Standard" unless otherwise specified in EM Devices' Data Sheets or Data Books. If customers intend to use EM Devices' products for applications other than those specified for Standard quality grade, they should contact an EM Devices sales representative in advance.

(Note)

- (1) "EM Devices" as used in this statement means EM Devices Corporation and also includes its majority-owned subsidiaries.
- (2) "EM Devices electronic component products" means any electronic component product developed or manufactured by or for EM Devices (as defined above).



- All specifications in this catalog and production status of products are subject to change without notice. Prior to the purchase, please contact EM Devices for updated product data.
- Please request for a specification sheet for detailed product data prior to the purchase.
- Before using the product in this catalog, please read "Precautions" and other safety precautions listed in the printed version catalog.

[MEMO]



- All specifications in this catalog and production status of products are subject to change without notice. Prior to the purchase, please contact EM Devices for updated product data.
- Please request for a specification sheet for detailed product data prior to the purchase.
- Before using the product in this catalog, please read "Precautions" and other safety precautions listed in the printed version catalog.

## CONTENTS

<b>1. Preface</b> .....	<b>7</b>
<b>2. Structure</b> .....	<b>8</b>
<b>3. Basic Characteristics</b> .....	<b>9</b>
3.1 Switching power .....	9
3.2 Maximum coil voltage .....	9
3.3 Coil temperature rise .....	10
3.4 Driving power vs. timing .....	11
3.5 Thermal characteristics .....	12
3.6 Magnetic interference .....	13
3.7 High-frequency characteristics .....	14
3.8 Coil inductance .....	15
3.8.1 Measurement by LCR meter .....	15
3.8.2 Measurement by coil current waveform .....	15
3.9 Capacitance .....	16
3.10 Resistance to surge voltage .....	17
3.11 Resistance to carrying current .....	18
<b>4. Distribution of Characteristics</b> .....	<b>19</b>
4.1 Operate & release voltages (set & reset voltages) .....	19
4.2 Operate & release times (set & reset times) .....	20
4.3 Transfer time .....	21
4.4 Timing and details .....	22
4.5 Contact resistance .....	26
4.6 Breakdown voltage .....	27
4.7 Thermal Electromotive Force (EMF) (offset voltage between contacts) .....	27
<b>5. Test Data</b> .....	<b>28</b>
5.1 Environmental tests .....	29
5.1.1 High-temperature test .....	29
5.1.2 Low-temperature test .....	31
5.1.3 Moisture resistance test .....	32
5.1.4 Heat shock test .....	33
5.1.5 Vibration test .....	34
5.1.6 Shock test .....	35
5.1.7 Resistance to solder heat test (only ED2 series) .....	36
5.1.8 Resistance to reflow solder heat test (only EF2 series) .....	37
5.1.9 Terminal strength test (only ED2 series) .....	39
5.2 Contact life tests .....	40
5.2.1 Non-load test (Mechanical life test, $T_a = 25^\circ\text{C}$ ) .....	40
5.2.2 Resistive load test A (10 vdc, 10 mA, $T_a = 85^\circ\text{C}$ ) .....	41
5.2.3 Resistive load test B (50 vdc, 110 mA, $T_a = 25^\circ\text{C}$ ) .....	41
5.2.4 Resistive load test C (30 vdc, 1 A, $T_a = 25^\circ\text{C}$ ) .....	42



- All specifications in this catalog and production status of products are subject to change without notice. Prior to the purchase, please contact EM Devices for updated product data.
- Please request for a specification sheet for detailed product data prior to the purchase.
- Before using the product in this catalog, please read "Precautions" and other safety precautions listed in the printed version catalog.

[MEMO]



- All specifications in this catalog and production status of products are subject to change without notice. Prior to the purchase, please contact EM Devices for updated product data.
- Please request for a specification sheet for detailed product data prior to the purchase.
- Before using the product in this catalog, please read "Precautions" and other safety precautions listed in the printed version catalog.

## 1. Preface

Miniature signal relays are used in a wide range of application fields including communication, measurement, and factory automation. This document gives the basic characteristics and test data of NEXEM's ED2 and EF2 series miniature signal relays.

- Notes**
1. The symbol  $\top$  shown in the graphs throughout this document indicates the maximum value of the data. Likewise,  $\perp$  indicates the minimum value, and  $\phi(\ast)$  indicates the mean value.
  2. When a relay is driven by an IC, a protective element such as a diode may be connected in parallel with the relay coil to protect the IC from damage caused by the counter-electromotive force (EMF) due to the inductance of the coil. There  $\bullet\bullet$ , unless otherwise specified, the operate time and release time (set and reset times) shown in this document are measured with such a protective element.

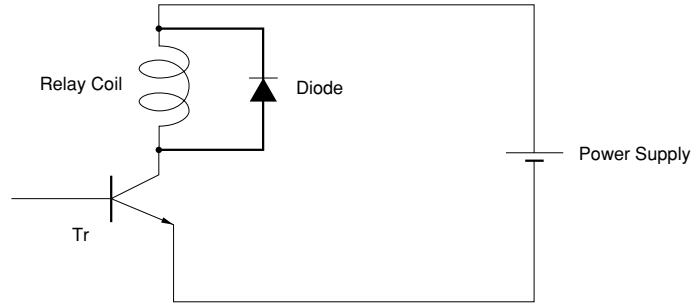

### For Right Use of Miniature Relays

#### **DO NOT EXCEED MAXIMUM RATINGS.**

Do not use relays under exceeding conditions such as over ambient temperature, over voltage and over current. Incorrect use could result in abnormal heating, damage to related parts or cause burning.

#### **READ CAUTIONS IN THE SELECTION GUIDE.**

Read the cautions described in EM Devices' "Miniature Relays" when you choose relays for your application.



- All specifications in this catalog and production status of products are subject to change without notice. Prior to the purchase, please contact EM Devices for updated product data.
- Please request for a specification sheet for detailed product data prior to the purchase.
- Before using the product in this catalog, please read "Precautions" and other safety precautions listed in the printed version catalog.

## 2. Structure

Figure 2.1 shows the structures of the ED2 and the EF2 series relays. ED2 series relay has a terminal configuration called dual in-line leads (DIL), and EF2 series relay has a resistibility to solder heat, and a terminal configuration that conforms to surface mounting. Table 2.1 lists the parts constituting relay.

ED2 series and EF2 series relays have a common structure except difference of a terminal configuration and some parts.

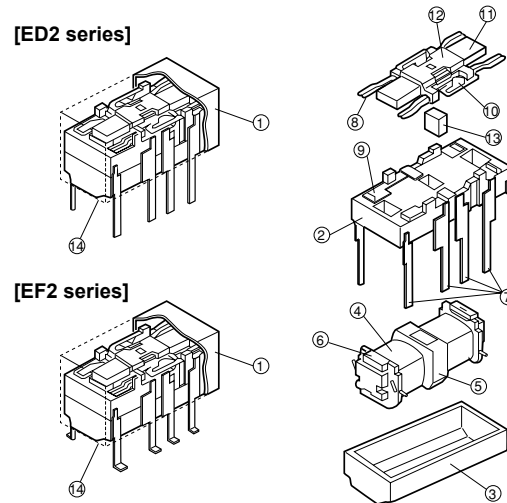

Figure 2.1 Structure of the ED2/EF2 Series Relay

Table 2.1 Parts of ED2/EF2 Series Relay

No.	Parts	Material
		ED2/EF2 Series
1	Cover	Liquid crystalline polymer#
2	Base	Liquid crystalline polymer#
3	Base pad	Liquid crystalline polymer#
4	Coil wire	Polyurethane copper wire
5	Coil spool	Polyphenylene sulfide#
6	Core	Pure iron
7	Terminal	Phosphor bronze (surface is treated with preparatory solder)
8	Moving contact	Au-alloy + Ag-alloy
9	Stationary contact	Au-alloy + Ag-alloy
10	Contact spring	Phosphor bronze
11	Armature	Pure iron
12	Armature block mold	Liquid crystalline polymer#
13	Magnet	Cobalt magnet
14	Sealing material	Epoxy resin

**Note:** Note RoHS Compliant

#: Conforms to UL94V-0



- All specifications in this catalog and production status of products are subject to change without notice. Prior to the purchase, please contact EM Devices for updated product data.
- Please request for a specification sheet for detailed product data prior to the purchase.
- Before using the product in this catalog, please read "Precautions" and other safety precautions listed in the printed version catalog.



### 3. Basic Characteristics

This section provides data necessary for designing an external circuit that uses the relay.

ED2 and EF2 series relays are designed with common specifications. So, this section shows common characteristics of ED2 and EF2 series.

#### 3.1 Switching power

If the contact load voltage and current of the relay are in the region enclosed by the solid and dotted lines in the figure below, the relay can perform stable switching operation. If the relay is used at a voltage or current exceeding this region, the life of the contacts may be significantly shortened.

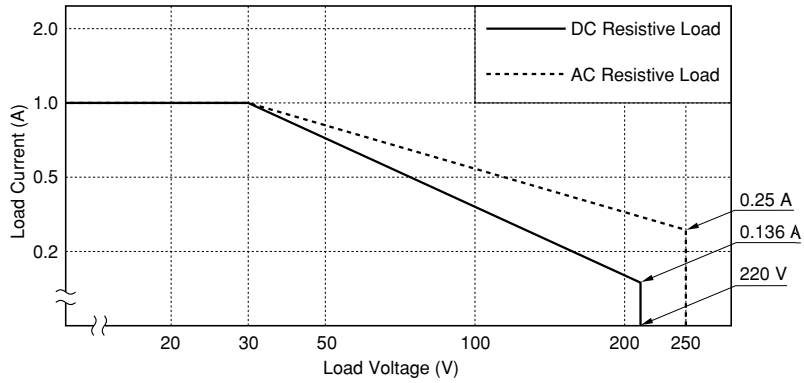

Figure 3.1 Switching Power

#### 3.2 Maximum coil voltage

Figure 3.2 shows the ratio of maximum voltage that can be continuously applied to the coil of the relay to the nominal voltage. As long as the relay is used in the enclosed region in this figure, the coil is not damaged due to burning and the coil temperature does not rise to an abnormally high level.

(\* Rated Coil Voltage: 3 to 24 Vdc)

(Rated of decrease in maximum voltage: 50%/45°C)

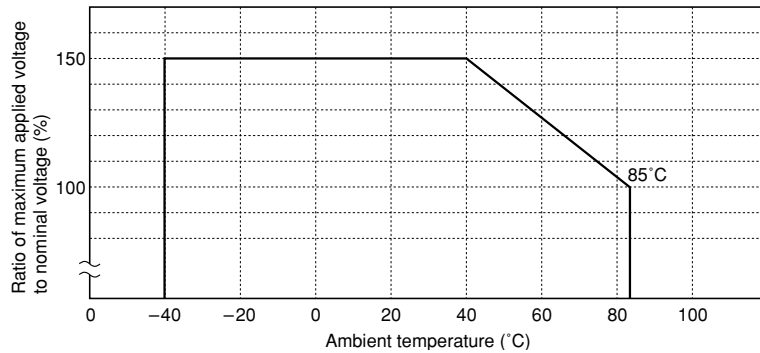

Figure 3.2 Maximum Voltage Applied to Coil



- All specifications in this catalog and production status of products are subject to change without notice. Prior to the purchase, please contact EM Devices for updated product data.
- Please request for a specification sheet for detailed product data prior to the purchase.
- Before using the product in this catalog, please read "Precautions" and other safety precautions listed in the printed version catalog.

### 3.3 Coil temperature rise

Figure 3.3 shows the relation between the rise in coil temperature and the power (product of the coil voltage and current) dissipated by the coil. This figure shows the difference between the temperature before the power is applied to the coil and the saturated temperature after application of power to the coil.

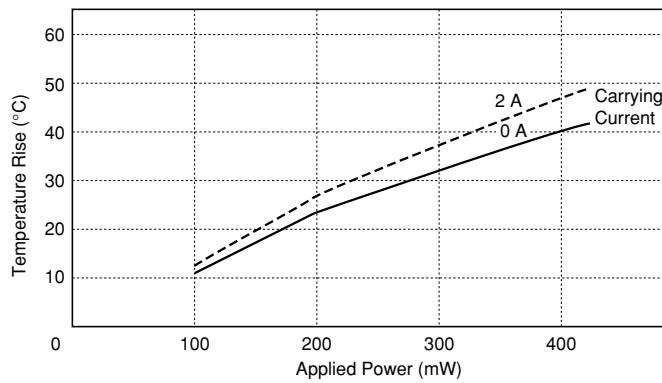

Figure 3.3 Coil Temperature Rise



- All specifications in this catalog and production status of products are subject to change without notice. Prior to the purchase, please contact EM Devices for updated product data.
- Please request for a specification sheet for detailed product data prior to the purchase.
- Before using the product in this catalog, please read "Precautions" and other safety precautions listed in the printed version catalog.

### 3.4 Driving power vs. timing

Figure 3.4 (1) shows the relations among the power applied to drive the relay, the operate time, and the bounce time. Figure 3.4 (2) shows the relations among the supplied power, the release time, and the bounce time, and Figure 3.4 (3) shows the relations among the supplied power, the release time, and the bounce time when a diode is not connected to the coil to absorb surges.

#### (1) Operate time

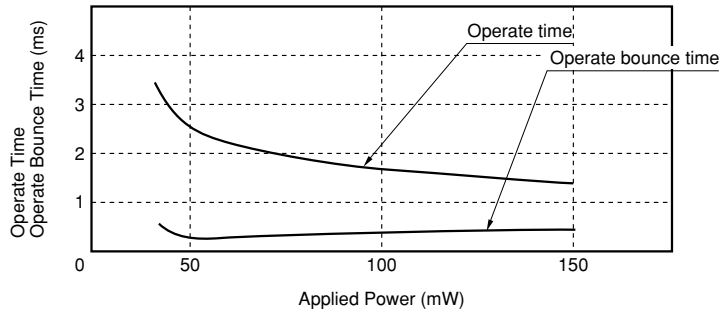

#### (2) Release time

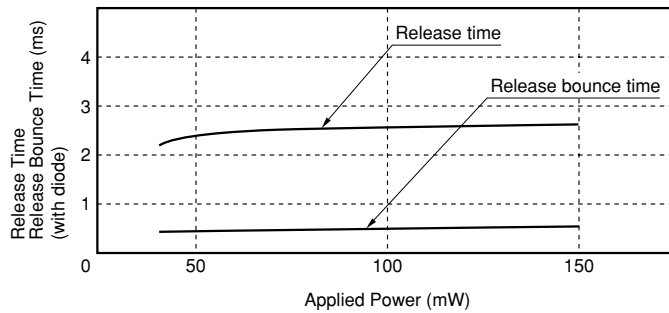

#### (3) Release time (without diode)

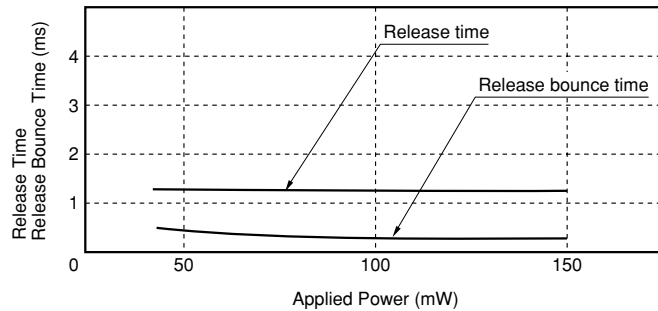

Figure 3.4 Driving Power vs. Timing



- All specifications in this catalog and production status of products are subject to change without notice. Prior to the purchase, please contact EM Devices for updated product data.
- Please request for a specification sheet for detailed product data prior to the purchase.
- Before using the product in this catalog, please read "Precautions" and other safety precautions listed in the printed version catalog.

### 3.5 Thermal characteristics

The general characteristics of a relay gradually change with the ambient temperature. Figure 3.5 shows the typical characteristics of the ED2 series relay.

#### (1) Operate & release voltages

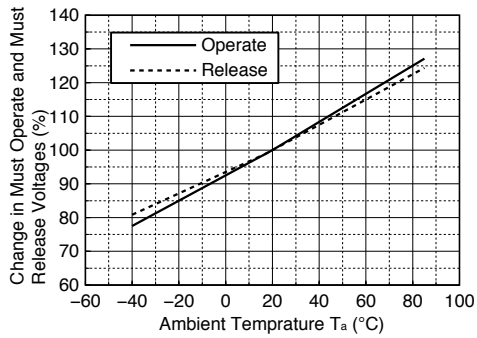

#### (2) Contact resistance\*

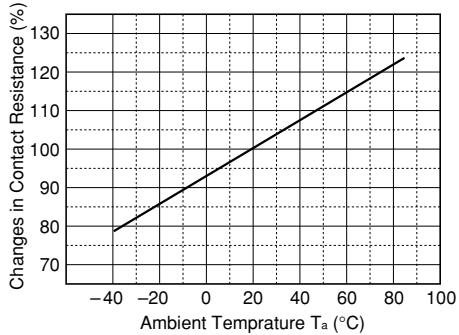

#### (4) Transfer times

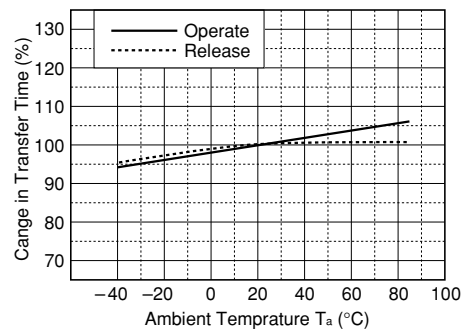

#### (3) Operate & release times

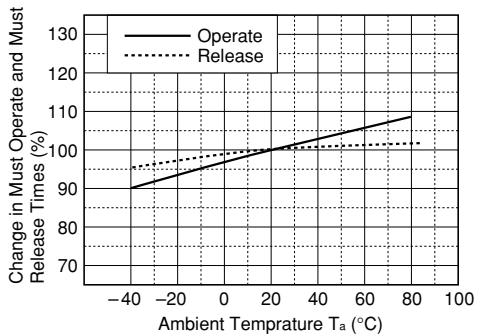

#### (5) Coil resistance

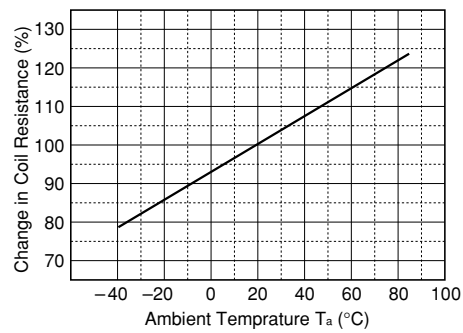

Figure 3.5 Temperature Characteristics

\* The contact resistance includes the conductive resistance of the terminals. It is this conductive resistance component that can change with the temperature.



- All specifications in this catalog and production status of products are subject to change without notice. Prior to the purchase, please contact EM Devices for updated product data.
- Please request for a specification sheet for detailed product data prior to the purchase.
- Before using the product in this catalog, please read "Precautions" and other safety precautions listed in the printed version catalog.

### 3.6 Magnetic interference

This section describes changes in the operate voltage caused by mutual magnetic interference when several relays are closely mounted on a printed circuit board (PCB). Figure 3.6 (1) shows the distance among the relays mounted on the PCB. As shown, the pin pitch of each relay is 2.54 mm. Figure 3.6 (2) shows the relay that is subject to interference. In this figure, the hatched relay shown in the center of each relay arrangement is subject to interference, and the surrounding relays influence the center relay. The condition under which the center relay suffers interference and the surrounding relays affect the center relay differs depending on whether power is supplied to each relay. Figure 3.6 (3) shows the deviation in percent of the operate and release voltages of the center relays in Figure 3.6 (2).

#### (1) Mounting pitch (mm)

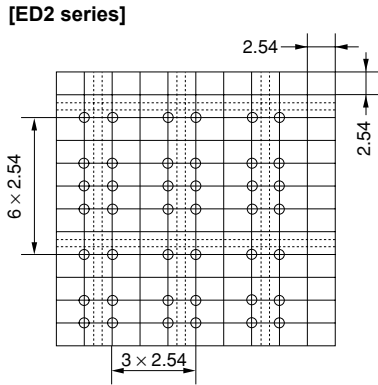

#### [EF2 series]

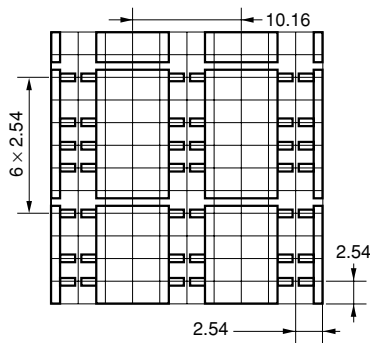

#### (2) Relay arrangement

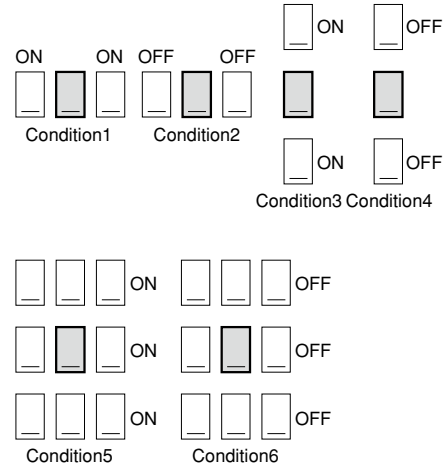

#### (3) Deviation of must operate and must release voltages

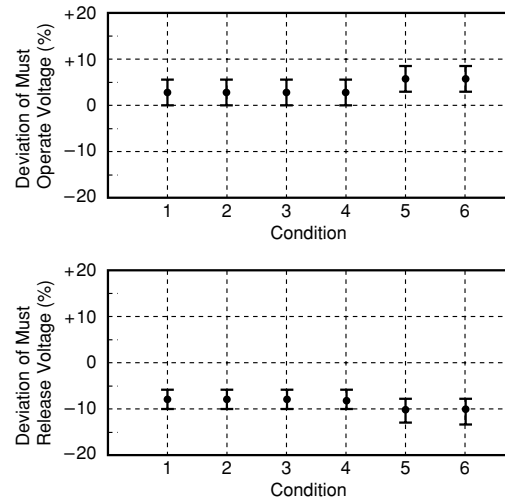

Figure 3.6 Magnetic Interference



- All specifications in this catalog and production status of products are subject to change without notice. Prior to the purchase, please contact EM Devices for updated product data.
- Please request for a specification sheet for detailed product data prior to the purchase.
- Before using the product in this catalog, please read "Precautions" and other safety precautions listed in the printed version catalog.

### 3.7 High-frequency characteristics

Figure 3.7 shows the performance of the ED2 and the EF2 series relays when a high-frequency signal is switched by the contacts of the relay. Figure 3.7 (1) shows the test circuit. Figure 3.7 (2) shows the isolation loss of the relay. Figure 3.7 (3) and Figure 3.7 (4) respectively show the insertion loss and return loss.

#### (1) Test circuit

Test equipment: HP8753B Network Analyzer (characteristic impedance: 50 Ω)

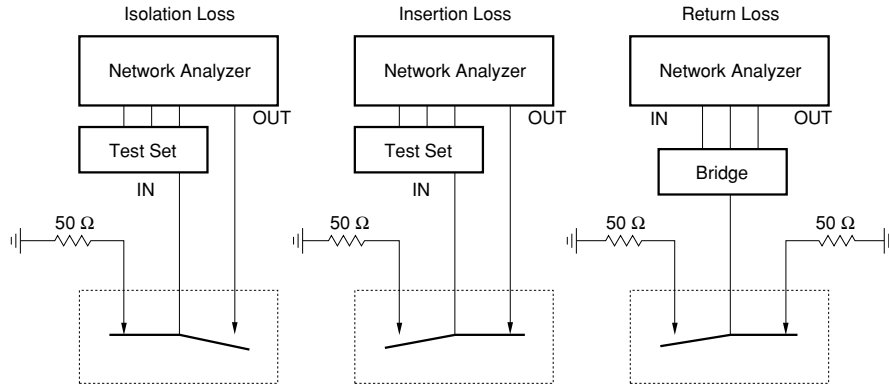

#### (2) Isolation loss

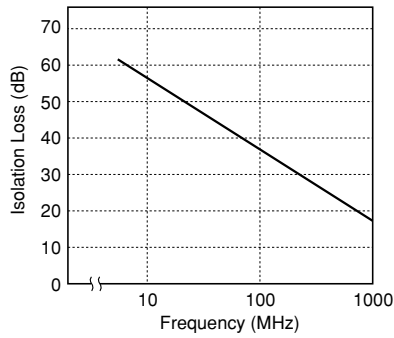

#### (3) Insertion loss

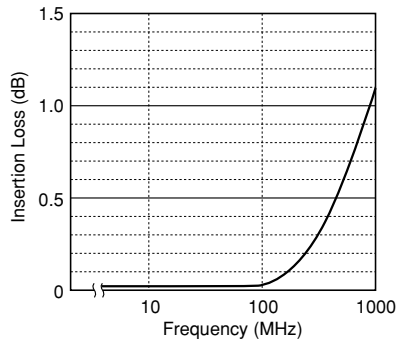

#### (4) Return loss

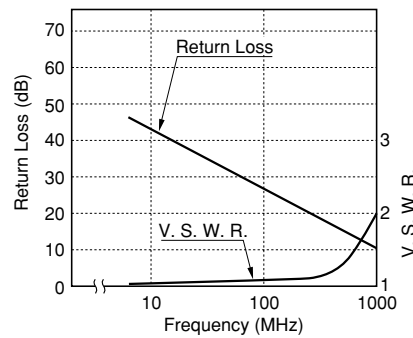

Figure 3.7 High-frequency characteristics



- All specifications in this catalog and production status of products are subject to change without notice. Prior to the purchase, please contact EM Devices for updated product data.
- Please request for a specification sheet for detailed product data prior to the purchase.
- Before using the product in this catalog, please read "Precautions" and other safety precautions listed in the printed version catalog.

### 3.8 Coil inductance

The control input of a relay is the coil. The coil inductance can be measured using the following two methods. Either method may be used based on preference.

Table 3.1.1 and 3.1.2 show the results of measurement.

#### 3.8.1 Measurement by LCR meter

**Table 3.1.1 Coil Inductance**  
(Unit: mH)

Part Number (Non-latching type) (Standard type)	Inductance
ED2/EF2-1.5NU	34
ED2/EF2-3NU	126
ED2/EF2-4.5NU	195
ED2/EF2-5NU	221
ED2/EF2-9NU	690
ED2/EF2-12NU	1103
ED2/EF2-24NU	3513

(Measurement frequency: 1 kHz)

#### 3.8.2 Measurement by coil current waveform

The inductance is calculated by observation of  $\tau$  equaling 63.2 % of max value

$\tau$ . Determined by current waveform  $I = I_{max} (1 - e^{-t/\tau})$ .

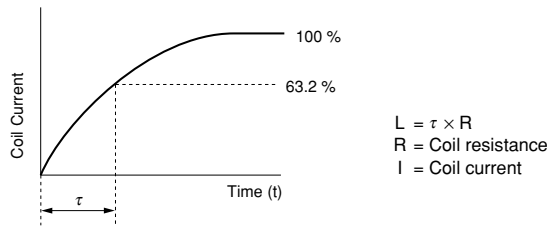

**Table 3.1.2 Coil Inductance**  
(Unit: mH)

Part Number (Non-latching type) (Standard type)	Inductance
ED2/EF2-1.5NU	9
ED2/EF2-3NU	50
ED2/EF2-4.5NU	80
ED2/EF2-5NU	150
ED2/EF2-9NU	320
ED2/EF2-12NU	600
ED2/EF2-24NU	2220

(Applied voltage = Nominal D.C. voltage)



- All specifications in this catalog and production status of products are subject to change without notice. Prior to the purchase, please contact EM Devices for updated product data.
- Please request for a specification sheet for detailed product data prior to the purchase.
- Before using the product in this catalog, please read "Precautions" and other safety precautions listed in the printed version catalog.

### 3.9 Capacitance

Table 3.2 shows the capacitance between terminals of the ED2 and the EF2 series relay. Note that the terminals not tested are left open.

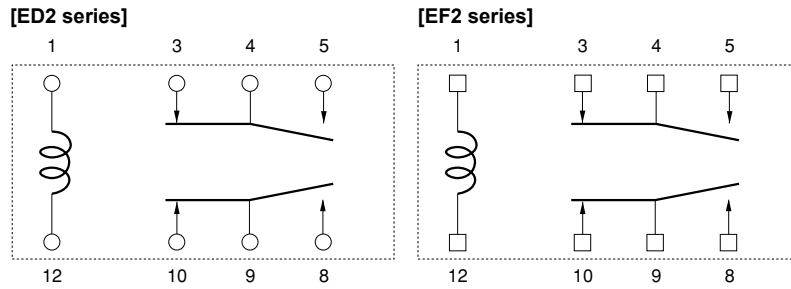

Internal Connection of Relay (Bottom View)

**Table 3.2 Capacitance**

(Unit: pF)

Parameter	Terminal Number	Capacitance
Between Coil and Contact	1, 4	1.6
	9, 12	1.6
Between Opening Contacts	4, 5	0.8
	8, 9	0.8
Between Adjacent Contacts	4, 8	0.5
	4, 9	0.8
	5, 8	0.3
	5, 9	0.5



- All specifications in this catalog and production status of products are subject to change without notice. Prior to the purchase, please contact EM Devices for updated product data.
- Please request for a specification sheet for detailed product data prior to the purchase.
- Before using the product in this catalog, please read "Precautions" and other safety precautions listed in the printed version catalog.



### 3.10 Resistance to surge voltage

When a relay is used in a communication circuit, it may be subjected to a lightning surge via the circuit or due to induction. A surge voltage test is conducted to measure the resistance of the ED2 and the EF2 series relays to surge voltage.

#### (1) Test condition 1

The voltage waveform used for this test is specified by the Federal Communications Commission (FCC) Standard Part 68.

The ED2 series relay can withstand even if the surge voltage shown in Figure 3.8 is applied (1) between opening contacts, (2) between coil and contacts, or (3) between adjacent contacts.

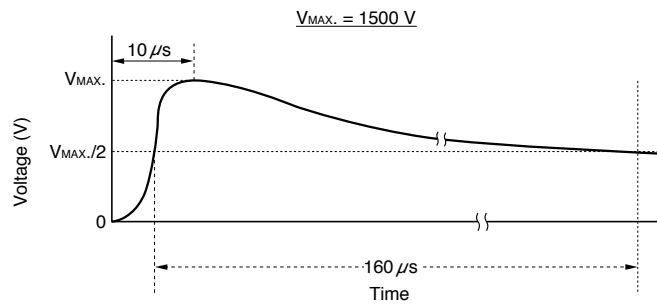

Figure 3.8 Surge Voltage Waveform

#### (2) Test condition 2

The voltage waveform used for this test is specified by the Bellcore Standard. The ED2 and the EF2 series relay can withstand even if the surge voltage shown in Figure 3.9 is applied between coil and contact.

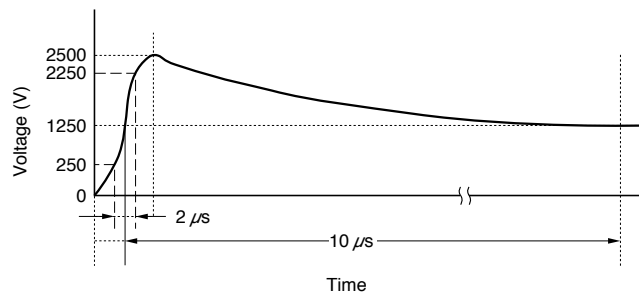

Figure 3.9 Surge Current Waveform



- All specifications in this catalog and production status of products are subject to change without notice. Prior to the purchase, please contact EM Devices for updated product data.
- Please request for a specification sheet for detailed product data prior to the purchase.
- Before using the product in this catalog, please read "Precautions" and other safety precautions listed in the printed version catalog.

### 3.11 Resistance to carrying current

If an abnormally high current flows continuously through the closed contacts of the relay for a long time, meltdown of inner mold of the relay, and large deviation of characteristics may occur.

Figure 3.10 shows the relation between the value of the carrying current at which the relay can operate normally and time.

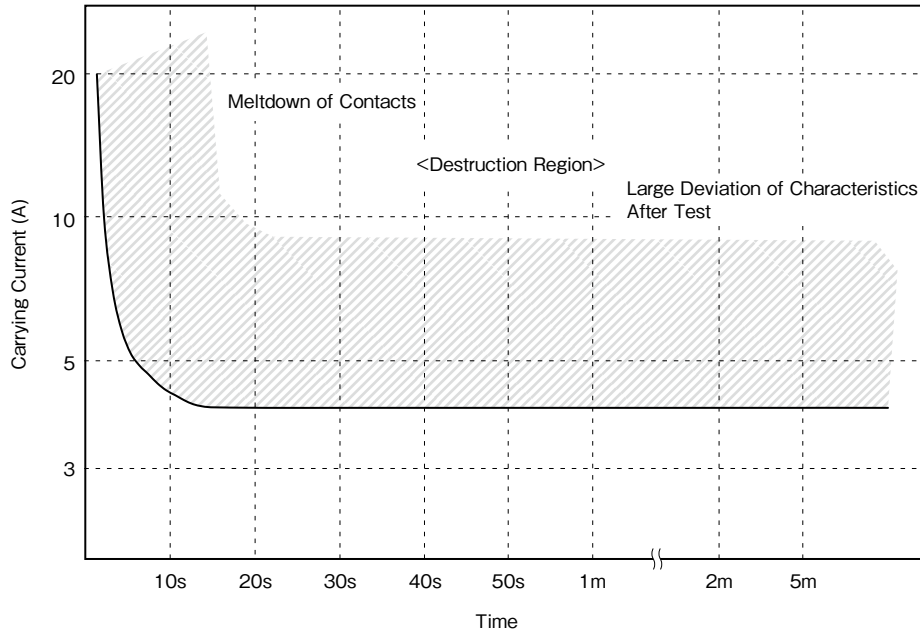

Figure 3.10 Resistance to Carrying Current

(Hints on correct use)

Limit the carrying current of the contacts to a maximum of 2 A to maintain the reliability of the relay.



- All specifications in this catalog and production status of products are subject to change without notice. Prior to the purchase, please contact EM Devices for updated product data.
- Please request for a specification sheet for detailed product data prior to the purchase.
- Before using the product in this catalog, please read "Precautions" and other safety precautions listed in the printed version catalog.

#### 4. Distribution of Characteristics

This chapter presents the distribution data of the general characteristic values of the ED2 series relay on behalf of the ED2 and the EF2 series relays, because they are designed with common specifications. The data shown in this chapter are sampled from a certain production lot, and do not necessarily guarantee the characteristics of any particular lot that is shipped. The number of samples is 40 relays for each test.

##### 4.1 Operate & release voltages

This section shows the distribution of the voltage at which the relay operates.

###### (1) Non-latching, 5-V type (ED2-5NU)

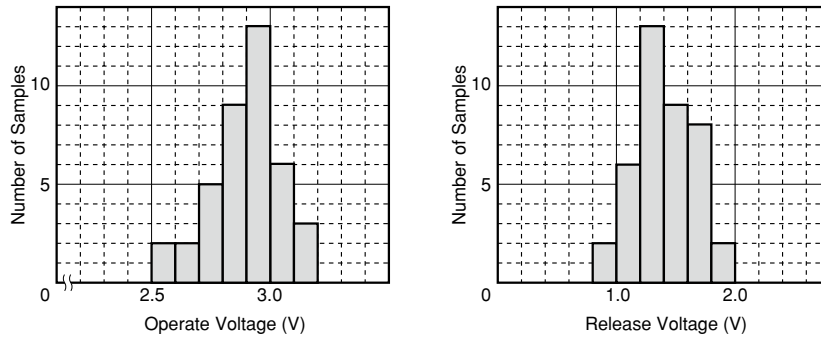

###### (2) Non-latching, 12-V type (ED2-12NU)

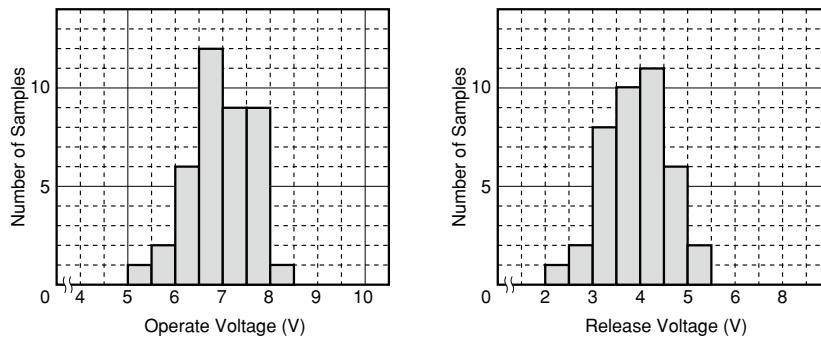

Figure 4.1 Operate & Release Voltages



- All specifications in this catalog and production status of products are subject to change without notice. Prior to the purchase, please contact EM Devices for updated product data.
- Please request for a specification sheet for detailed product data prior to the purchase.
- Before using the product in this catalog, please read "Precautions" and other safety precautions listed in the printed version catalog.

## 4.2 Operate & release times

This section shows the operate time that elapses from the time when the relay coil is energized until the relay contacts close, and the release time that elapses from the time when the relay coil is deenergized until the closed contacts open.

The number of samples used for each measurement is 40.

### (1) Non-latching, 5-V type (ED2-5NU)

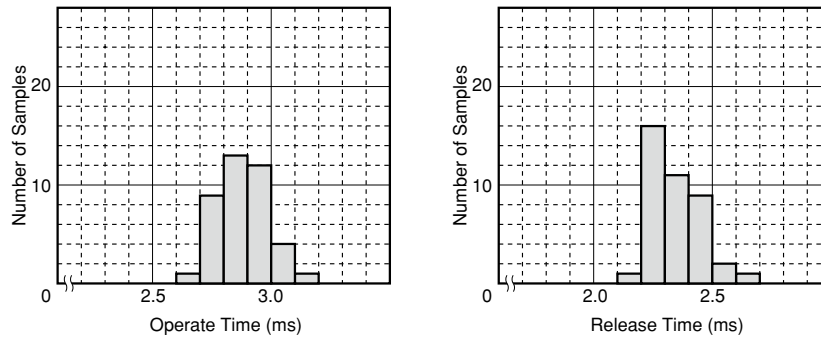

### (2) Non-latching, 12-V type (ED2-12NU)

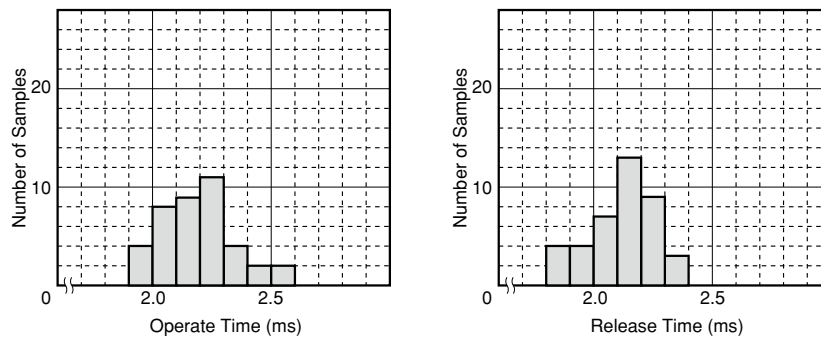

Figure 4.2 Operate & Release Times



- All specifications in this catalog and production status of products are subject to change without notice. Prior to the purchase, please contact EM Devices for updated product data.
- Please request for a specification sheet for detailed product data prior to the purchase.
- Before using the product in this catalog, please read "Precautions" and other safety precautions listed in the printed version catalog.

### 4.3 Transfer time

This section gives data on the transfer time, which is the total time between the breaking of one set of contacts and the making of another. The number of samples used for each measurement of the transfer time is 40.

#### (1) Non-latching, 5-V type (ED2-5NU)

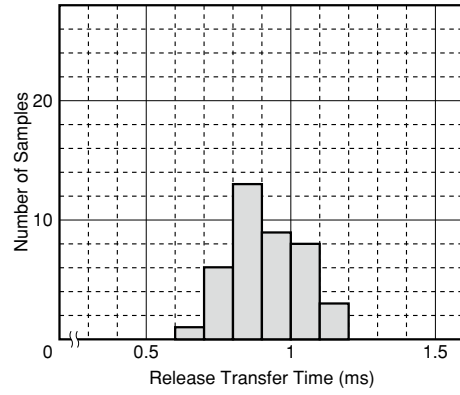
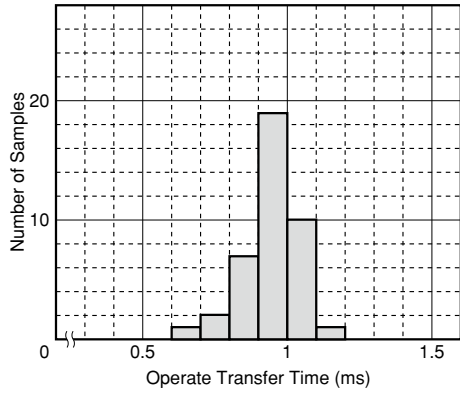

#### (2) Non-latching, 12-V type (ED2-12NU)

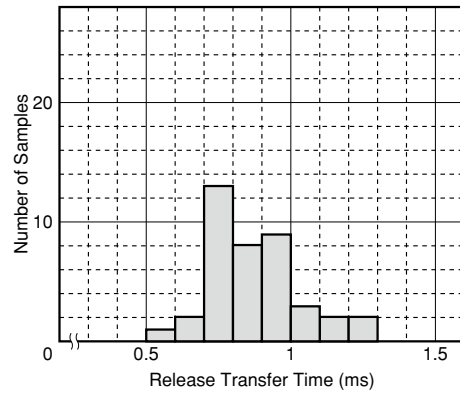
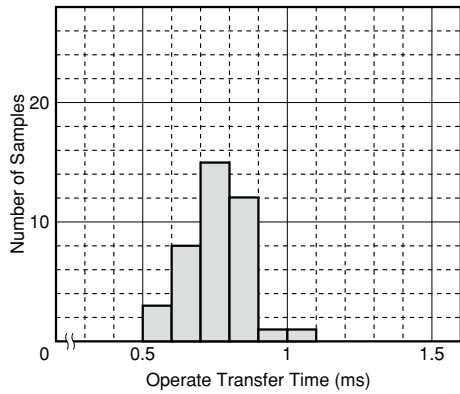

Figure 4.3 Transfer Times



- All specifications in this catalog and production status of products are subject to change without notice. Prior to the purchase, please contact EM Devices for updated product data.
- Please request for a specification sheet for detailed product data prior to the purchase.
- Before using the product in this catalog, please read "Precautions" and other safety precautions listed in the printed version catalog.

#### 4.4 Timing and details

The ED2 and the EF2 series relays have two sets of transfer contacts. This section shows the movements of each contact, which are not included in the timing specifications, using the timing chart shown in Figure 4.4A.

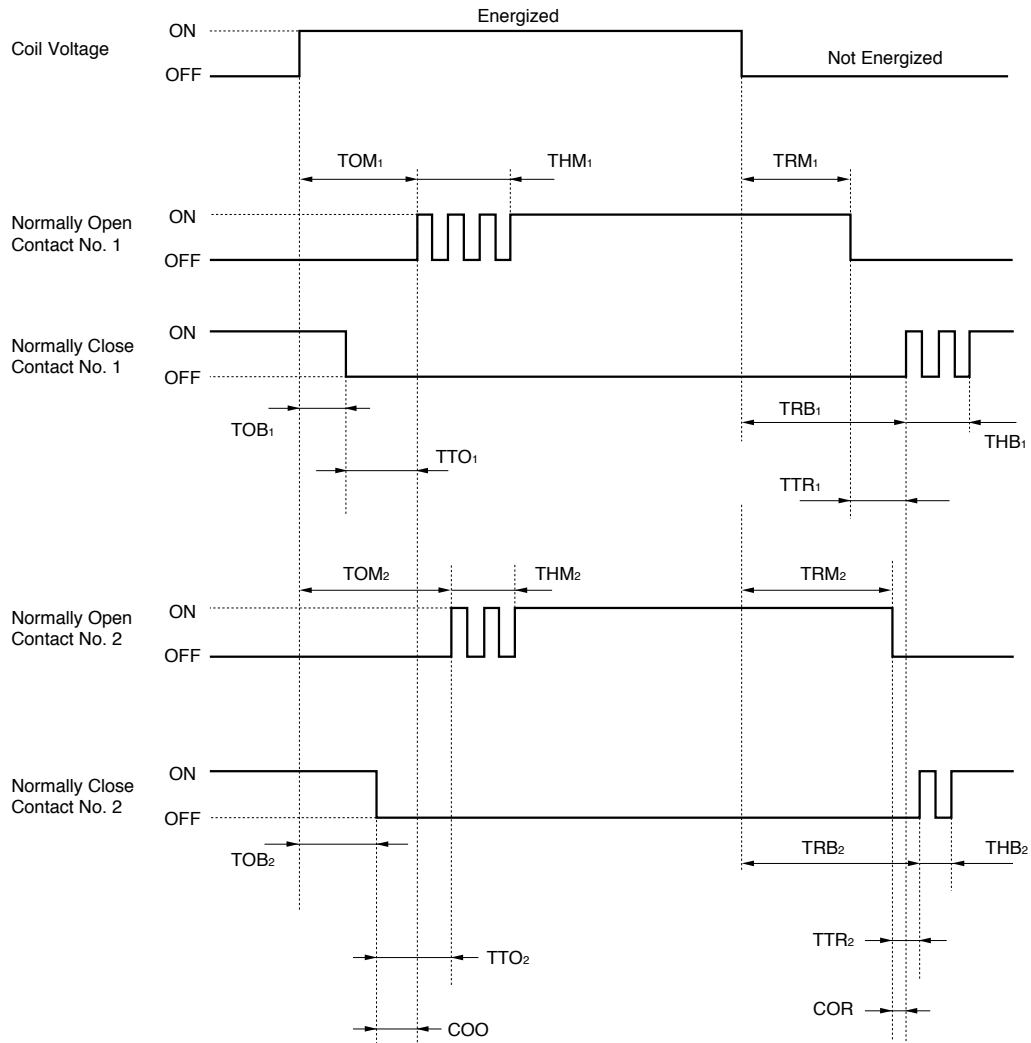

Figure 4.4A Timing Chart of Coil and Contacts

(Test results)

The timing specifications show the greater of the values of the two sets of contacts. The time difference between the two contact sets, however, is almost negligible as shown in data (1) through (8) on the following pages. Practically, therefore, the time difference can be ignored.



- All specifications in this catalog and production status of products are subject to change without notice. Prior to the purchase, please contact EM Devices for updated product data.
- Please request for a specification sheet for detailed product data prior to the purchase.
- Before using the product in this catalog, please read "Precautions" and other safety precautions listed in the printed version catalog.

The following charts show the distribution of timing. Twenty ED2-5NU's are used as the samples.

**(1) On times of make contacts at operation (TOM)**

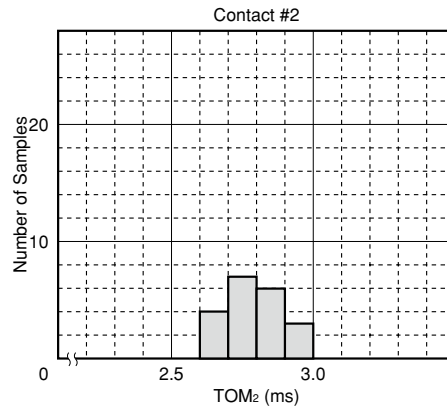
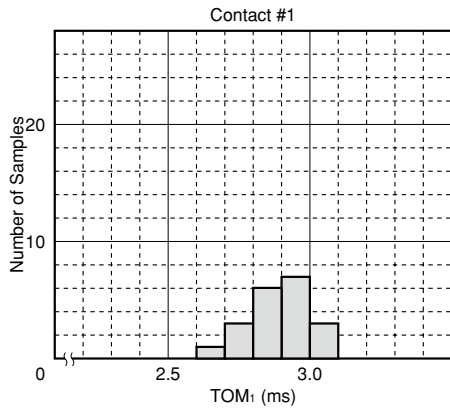

**(2) Off times of break contacts at operation (TOB)**

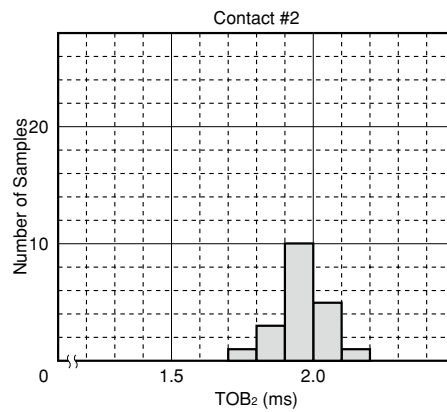
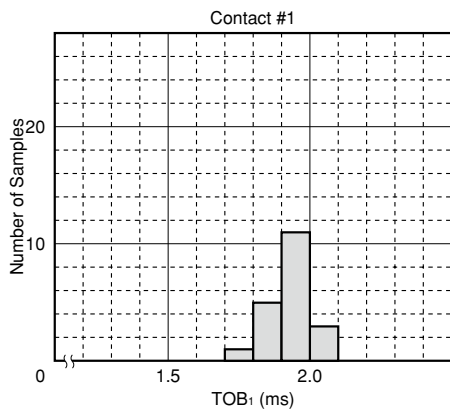

**(3) Off times of make contacts at release (TRM)**

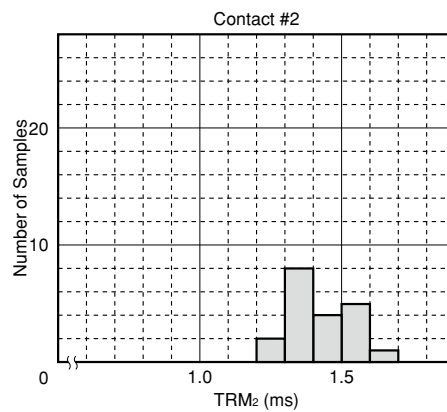
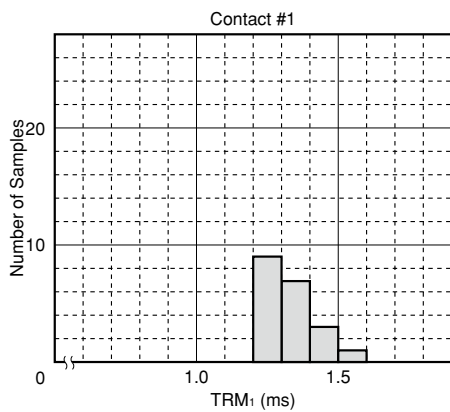
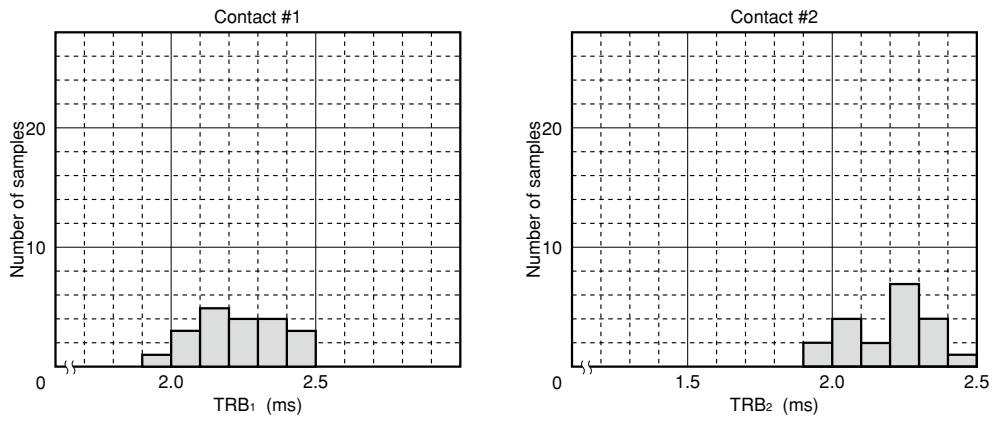

**Figure 4.4B Timing**



- All specifications in this catalog and production status of products are subject to change without notice. Prior to the purchase, please contact EM Devices for updated product data.
- Please request for a specification sheet for detailed product data prior to the purchase.
- Before using the product in this catalog, please read "Precautions" and other safety precautions listed in the printed version catalog.

**(4) On times of break contacts at release (TRB)**



**(5) Bounce times of make contacts at operation (THM)**

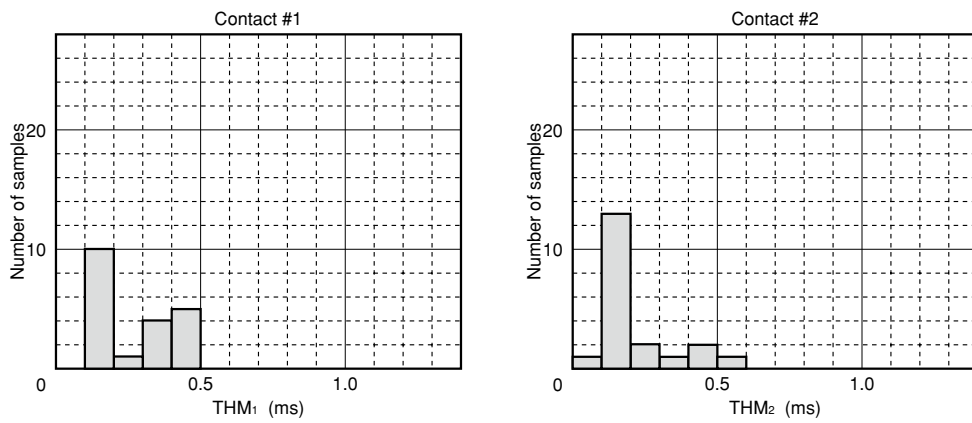

**(6) Bounce times of break contacts at release (THB)**

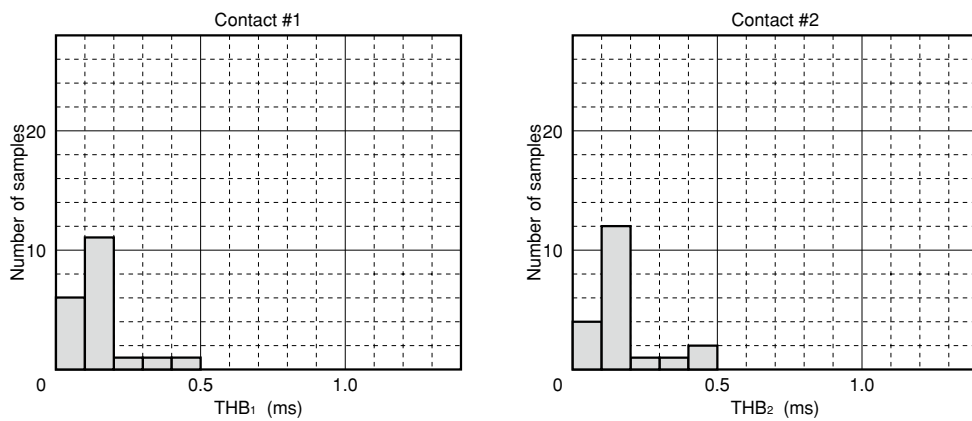

**Figure 4.4C Timing**



- All specifications in this catalog and production status of products are subject to change without notice. Prior to the purchase, please contact EM Devices for updated product data.
- Please request for a specification sheet for detailed product data prior to the purchase.
- Before using the product in this catalog, please read "Precautions" and other safety precautions listed in the printed version catalog.



**(7) Operate transfer times (TTO)**

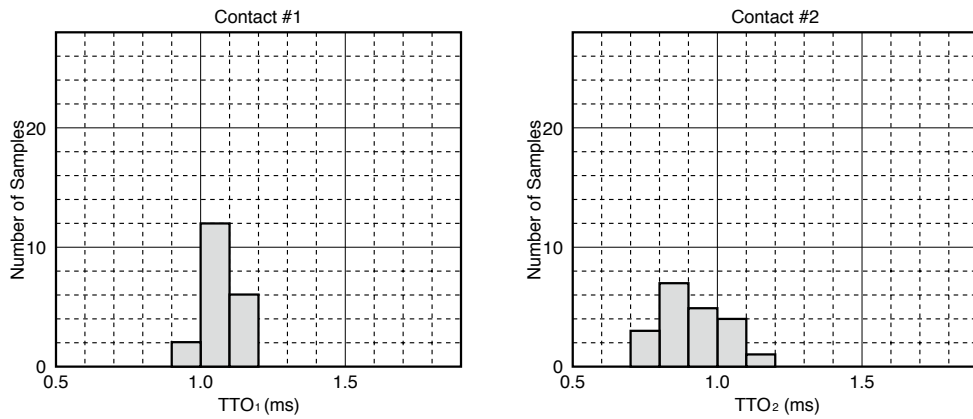

**(8) Release transfer times (TTR)**

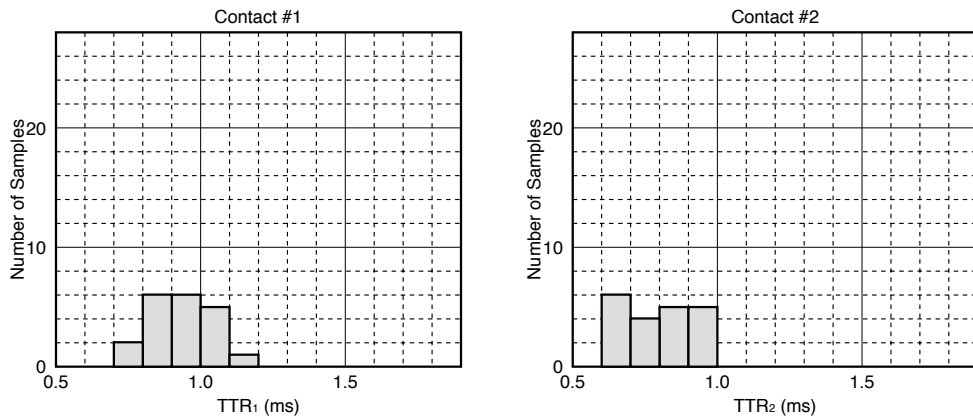

**(9) Common open times**

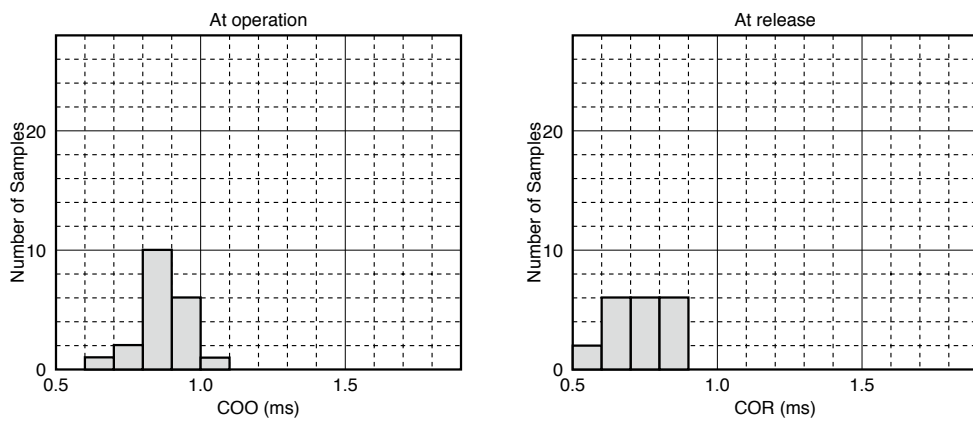

**Figure 4.4D Timing**



- All specifications in this catalog and production status of products are subject to change without notice. Prior to the purchase, please contact EM Devices for updated product data.
- Please request for a specification sheet for detailed product data prior to the purchase.
- Before using the product in this catalog, please read "Precautions" and other safety precautions listed in the printed version catalog.

#### 4.5 Contact resistance

This section gives data on the resistance of the contacts when the contacts are closed. The number of sample used for measurement of the contact resistance is 40 each.

##### (1) Non-latching, 5-V type (ED2-5NU)

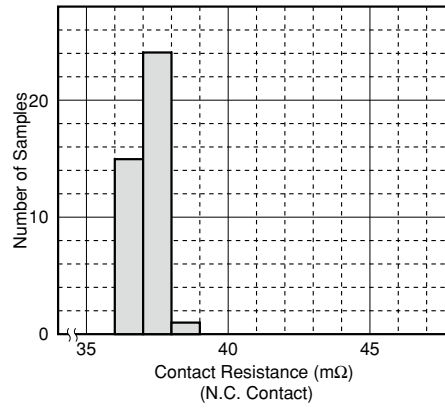
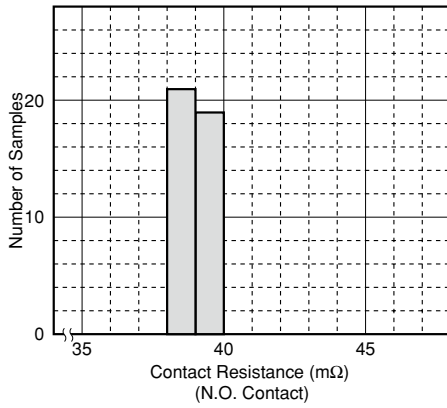

##### (2) Non-latching, 12-V type (ED2-12NU)

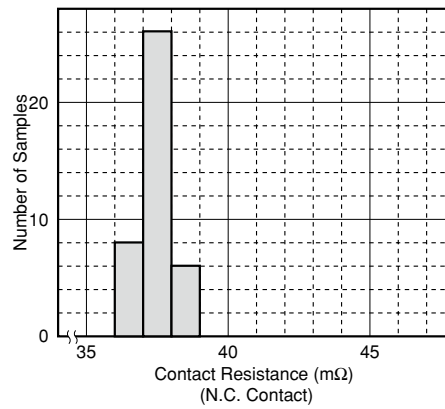
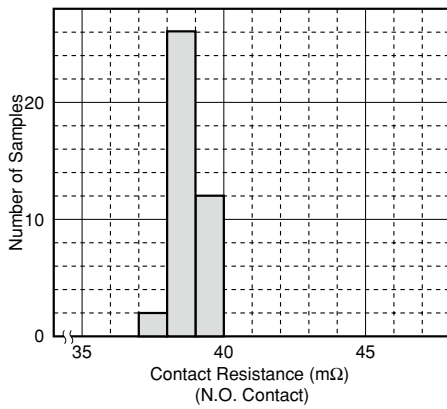

Figure 4.5 Contact Resistance



- All specifications in this catalog and production status of products are subject to change without notice. Prior to the purchase, please contact EM Devices for updated product data.
- Please request for a specification sheet for detailed product data prior to the purchase.
- Before using the product in this catalog, please read "Precautions" and other safety precautions listed in the printed version catalog.

#### 4.6 Breakdown voltage

This section gives data on the breakdown voltage between terminals of the ED2 series relay.  
 (Sample: ED2-5NU, n = 10pcs.)

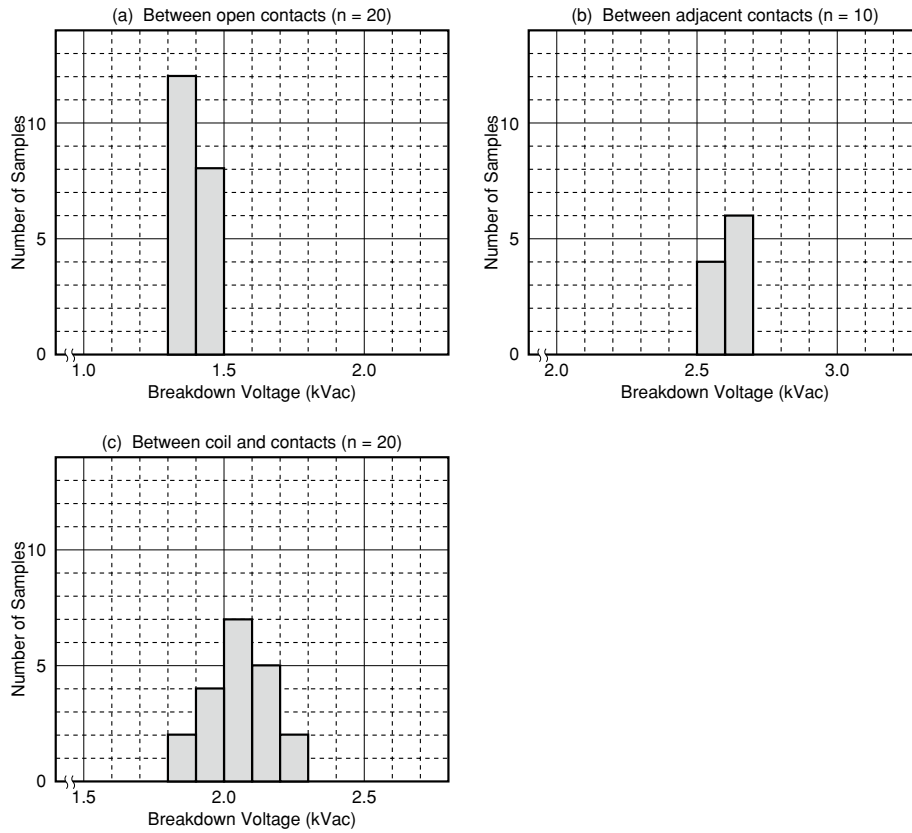

Figure 4.6 Breakdown Voltage

#### 4.7 Thermal Electromotive Force (EMF) (offset voltage between contacts)

This section gives data on the thermal EMF which is a voltage that appears when the contacts are closed.  
 (Sample: ED2-5NU, number of samples = 5 pcs., number of data = 10)

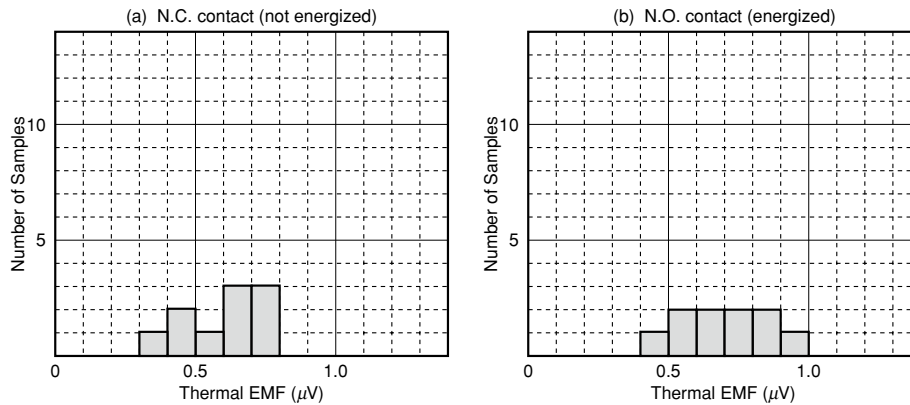

Figure 4.7 Thermal EMF



- All specifications in this catalog and production status of products are subject to change without notice. Prior to the purchase, please contact EM Devices for updated product data.
- Please request for a specification sheet for detailed product data prior to the purchase.
- Before using the product in this catalog, please read "Precautions" and other safety precautions listed in the printed version catalog.

## 5. Test Data

This chapter shows examples of the results of environmental tests (refer to 5.1 for details) and contact life tests (refer to 5.2). The table below lists the types of tests, conditions, and data.

**Table 5 Types of Tests, Conditions, and Data**

Test		Test Conditions	Refer to Page:
Environmental test	High-temperature test	Ambient temperature: +105°C Duration: 1000 hours	30
	Low-temperature test	Ambient temperature: -40°C Duration: 500 hours	31
	Moisture resistance test	Ambient temperature: -10°C to +65°C Humidity: 90 to 95% RH, test cycles: 10	32
	Heat shock test	Ambient temperature: -55°C/+85°C Test cycles: 100	33
	Vibration test	Amplitude: 1.52~5mm, Test time: energized 1 hour and not energized 1 hour Frequency: 10 Hz to 500 Hz, Peak acceleration: 294m/s <sup>2</sup>	34
	Shock test	Waveform: Half sine wave, 980m/s <sup>2</sup> max. 3 Times each in ±X, ±Y, and ±Z directions, totaling 18 times	35
	Resistance to solder heat test	Solder temperature: 260 ± 10°C Immersion time: 10 seconds	36
	Resistance to reflow solder heat test	Maximum temperature: 240°C, Expose twice Refer to Figure 5.8(1)	37, 38
	Terminal strength	Ambient temperature: 25°C, Tensile strength: 0.5kg, 10sec Bending: ±45°, 2 times	39
Contact test	Non-load test	25°C	40
	Resistive load test A	10 V.DC, 10 mA, 85°C	41
	Resistive load test B	50 V.DC, 100 mA, 85°C	41
	Resistive load test C	30 V.DC, 1 A, 25°C	42



- All specifications in this catalog and production status of products are subject to change without notice. Prior to the purchase, please contact EM Devices for updated product data.
- Please request for a specification sheet for detailed product data prior to the purchase.
- Before using the product in this catalog, please read "Precautions" and other safety precautions listed in the printed version catalog.

## 5.1 Environmental tests

This section shows the results of environmental tests to be conducted to evaluate the performance of the relay under specific storage and operating environmental conditions. No abnormality was found after all the tests had been conducted.

There is a difference between the shapes of the case and pins of the ED2 series and those of the EE2 series. However, apart from these differences, they have a common internal structure and are made of the same materials. The data indicated here is for the ED2 series. All values are the same for both the ED2 and EE2 series, except heat resistance when soldering (heat resistance when reflow soldering).

- \* The operate and release voltages, contact resistance, operate and release times, and transfer time of the sample before and after each test were compared, but no major change in these parameters was observed, and the sample still satisfied the initial standard values of the parameters after the test. For details, refer to the graph for each test.
- \* The initial standard value of the insulation resistance of  $10^9 \Omega$  or higher was still satisfied after the test.
- \* The initial standard value of two breakdown voltages of 1500 Vac (between coil and contact), and of 1000 Vac (between opening contacts, and between adjacent contacts) were satisfied for 1 minute after the test.
- \* After each test, no abnormality was found in the appearance. The cover of the relay was removed and the internal mechanism was also inspected visually for dirt, deformation, and other abnormalities, but no such abnormalities were found.
- \* After each test, a sealability test was conducted to examine the sealability of the relay by immersing the relay into a fluorocarbon solution and checking to see if the internal gas of the relay leaked out. No abnormality was observed as a result of this sealability test.



- All specifications in this catalog and production status of products are subject to change without notice. Prior to the purchase, please contact EM Devices for updated product data.
- Please request for a specification sheet for detailed product data prior to the purchase.
- Before using the product in this catalog, please read "Precautions" and other safety precautions listed in the printed version catalog.

**5.1.1 High-temperature test** (test conditions: temperature: +105°C, duration: 1000 hours, sample: 20 pcs. each)

This test was conducted to check whether the performance of the relay is degraded after the relay has been left at the upper-limit value of the rated ambient temperature for the specified duration.

**(1) Non-latching, 5-V type**

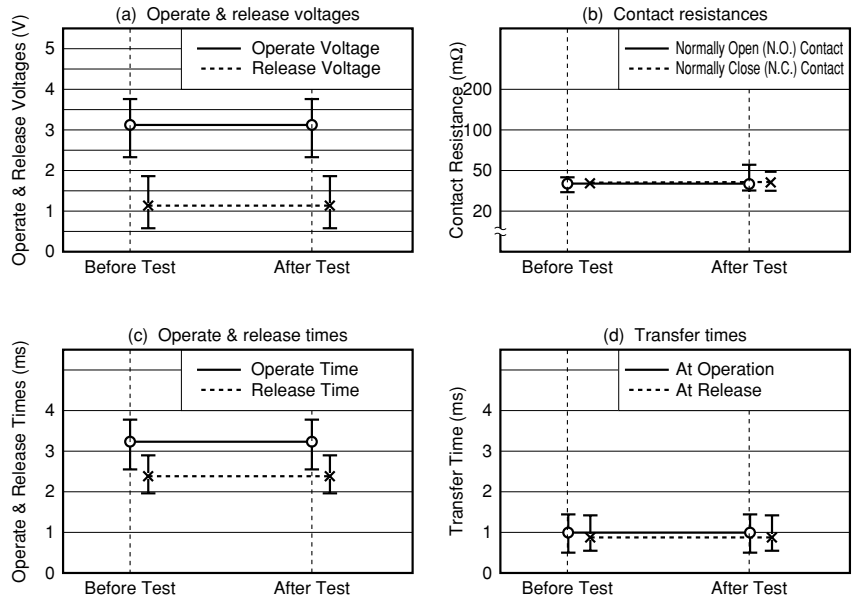

**Figure 5.1 High-temperature Test**



- All specifications in this catalog and production status of products are subject to change without notice. Prior to the purchase, please contact EM Devices for updated product data.
- Please request for a specification sheet for detailed product data prior to the purchase.
- Before using the product in this catalog, please read "Precautions" and other safety precautions listed in the printed version catalog.

**5.1.2 Low-temperature test** (test conditions: temperature:  $-40^{\circ}\text{C}$ , duration: 500 hours, sample: 20 pcs. each)

This test is conducted to check whether the performance of the relay is degraded after the relay has been left at the lower-limit value of the rated ambient temperature for the specified duration.

**(1) Non-latching, 5-V type**

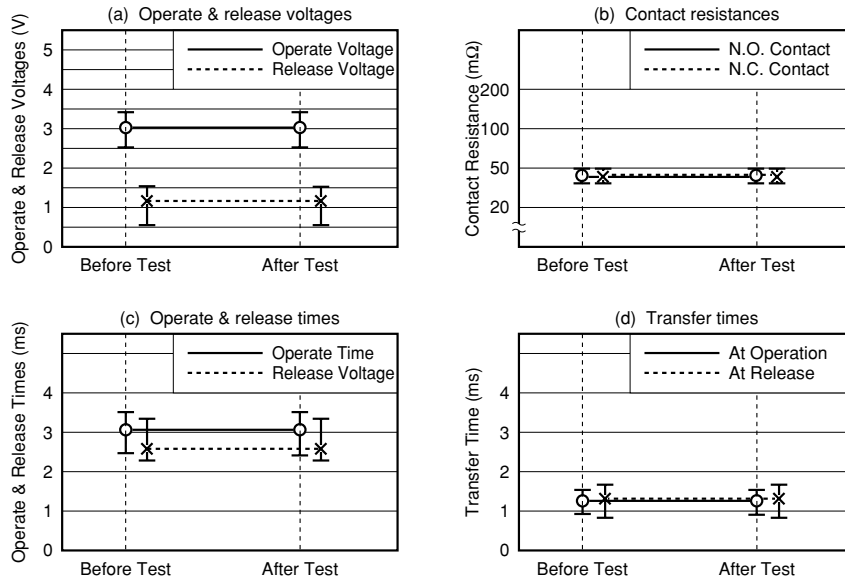

**Figure 5.2 Low-temperature Test**



- All specifications in this catalog and production status of products are subject to change without notice. Prior to the purchase, please contact EM Devices for updated product data.
- Please request for a specification sheet for detailed product data prior to the purchase.
- Before using the product in this catalog, please read "Precautions" and other safety precautions listed in the printed version catalog.

**5.1.3 Moisture resistance test** (test conditions: temperature:  $-10^{\circ}\text{C}$  to  $65^{\circ}\text{C}$ , humidity: 90 to 95% RH, test cycles: 10, sample: 20 pcs. each)

This test is conducted to check whether the performance of the relay is degraded after the relay has been left in a highly humid atmosphere for the specified duration.

**(1) Non-latching, 5-V type**

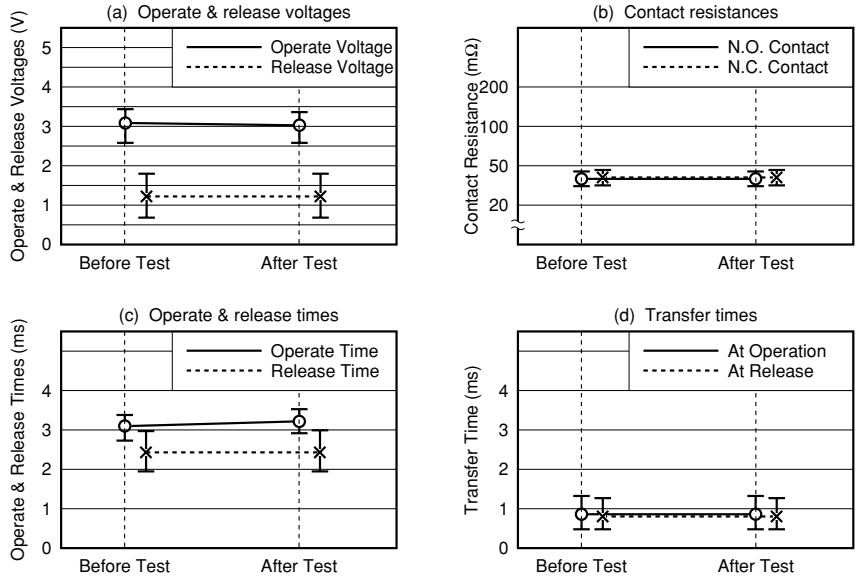

**Figure 5.3 Moisture Resistance Test**



- All specifications in this catalog and production status of products are subject to change without notice. Prior to the purchase, please contact EM Devices for updated product data.
- Please request for a specification sheet for detailed product data prior to the purchase.
- Before using the product in this catalog, please read "Precautions" and other safety precautions listed in the printed version catalog.



**5.1.4 Heat shock test** (test conditions: temperature:  $-55^{\circ}\text{C}$  to  $85^{\circ}\text{C}$ , test cycles: 100, sample: 20 pcs, each)

This test is to check whether the performance of the relay is degraded if the ambient temperature abruptly changes.

**(1) Non-latching, 5-V type**

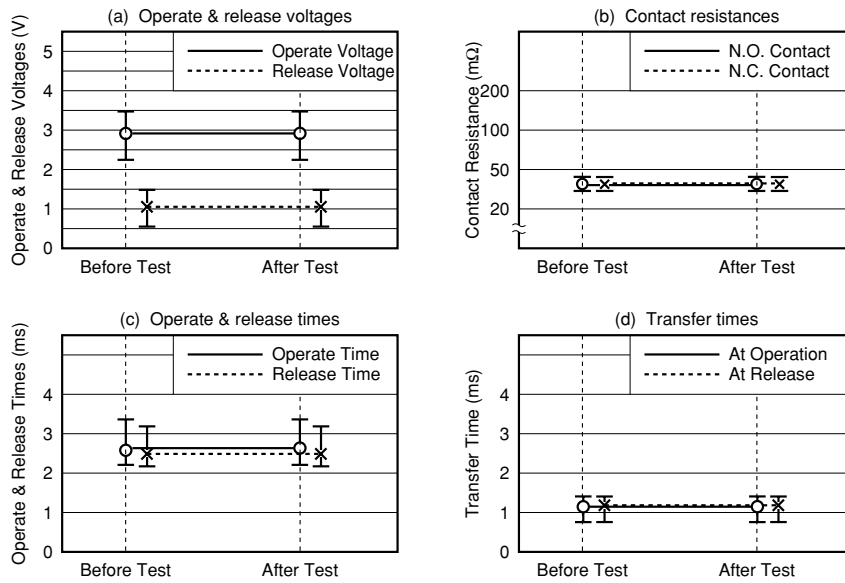

**Figure 5.4 Heat Shock Test**



- All specifications in this catalog and production status of products are subject to change without notice. Prior to the purchase, please contact EM Devices for updated product data.
- Please request for a specification sheet for detailed product data prior to the purchase.
- Before using the product in this catalog, please read "Precautions" and other safety precautions listed in the printed version catalog.

**5.1.5 Vibration test** (test conditions: amplitude: 1.52~5mm, frequency: 10 Hz to 500 Hz, 294m/s<sup>2</sup> peak, test time: energized 1 hour and not energized 1 hour each in X, Y, and Z directions, totaling 6 hours, sample: 20 pcs. each)

This test is conducted to check whether the performance of the relay is degraded after vibration is continuously applied to the relay while the relay is being transported.

**(1) Non-latching, 5-V type**

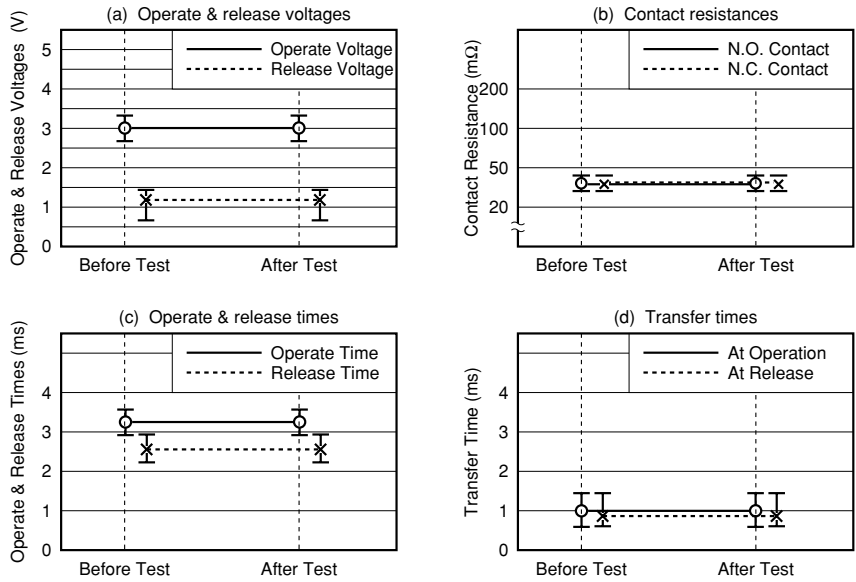

**Figure 5.5 Vibration Test**



- All specifications in this catalog and production status of products are subject to change without notice. Prior to the purchase, please contact EM Devices for updated product data.
- Please request for a specification sheet for detailed product data prior to the purchase.
- Before using the product in this catalog, please read "Precautions" and other safety precautions listed in the printed version catalog.

**5.1.6 Shock test** (test conditions: waveform: half sine wave, peak acceleration: 980m/s<sup>2</sup>, 3 times each in ±X,±Y, and ±Z directions, totaling 18 times, sample: 20 pcs. each)

This test is conducted to check whether the performance of the relay is degraded after an abrupt shock is applied to the relay while the relay is being transported.

**(1) Non-latching, 5-V type**

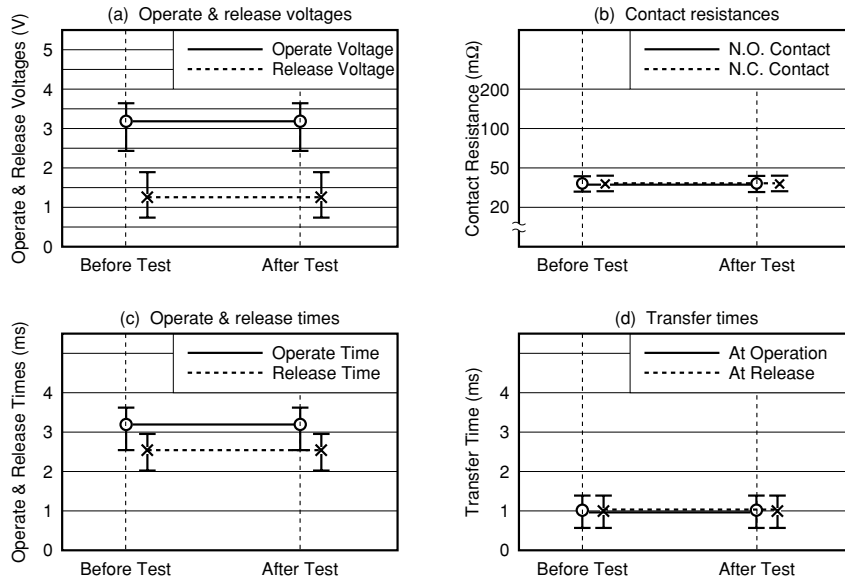

**Figure 5.6 Shock Test**



- All specifications in this catalog and production status of products are subject to change without notice. Prior to the purchase, please contact EM Devices for updated product data.
- Please request for a specification sheet for detailed product data prior to the purchase.
- Before using the product in this catalog, please read "Precautions" and other safety precautions listed in the printed version catalog.

**5.1.7 Resistance to solder heat test** (test conditions: solder temperature =  $260 \pm 10^\circ\text{C}$ , immersion time: 10 seconds, sample: 20 pcs. each)

This test is conducted to check whether the performance of the relay is degraded after the relay has been exposed to heat when it is soldered to a printed circuit board (PCB).

**(1) Non-latching, 5-V type**

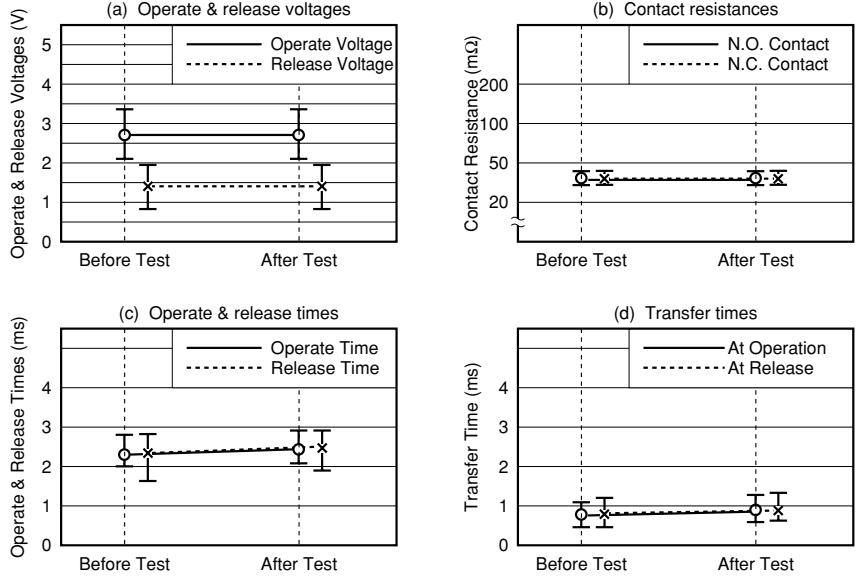

**Figure 5.7 Resistance to Solder Heat Test**



- All specifications in this catalog and production status of products are subject to change without notice. Prior to the purchase, please contact EM Devices for updated product data.
- Please request for a specification sheet for detailed product data prior to the purchase.
- Before using the product in this catalog, please read "Precautions" and other safety precautions listed in the printed version catalog.

### 5.1.8 Resistance to reflow solder heat test

This test is conducted to check whether the performance of the relay is degraded after the relay has been exposed to heat when it is soldered to a printed circuit board (PCB).

Test condition:

- |                                    |  |
|------------------------------------|--|
| <1> Soldering method:              | IRS (Infrared Ray Soldering)                           |
| <2> PCB:                           | Material epoxy-glass                                   |
|                                    | Thickness 1.6 mm                                       |
|                                    | Size 25 × 30 cm  |
| <3> Temperature measurement point: | Printed circuit board surface near the relay terminals |
| <4> Temperature profile:           | Refer to Figure 5.8 (1)                                |

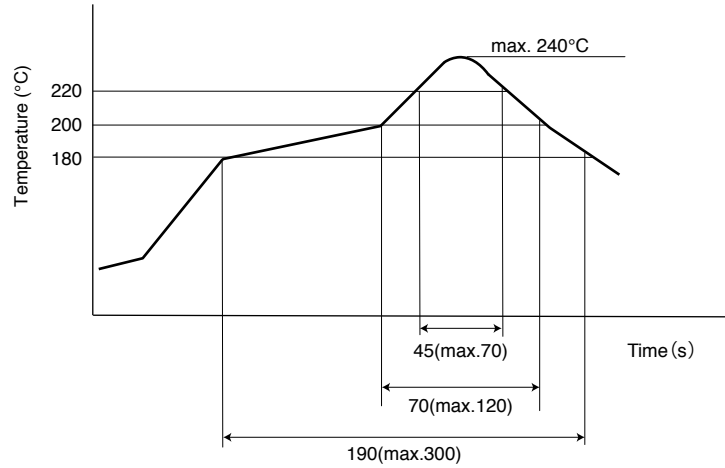

Figure 5.8 (1) Temperature Profiles



- All specifications in this catalog and production status of products are subject to change without notice. Prior to the purchase, please contact EM Devices for updated product data.
- Please request for a specification sheet for detailed product data prior to the purchase.
- Before using the product in this catalog, please read "Precautions" and other safety precautions listed in the printed version catalog.

[EF2 series]

(1) Non-latching, 5-V type

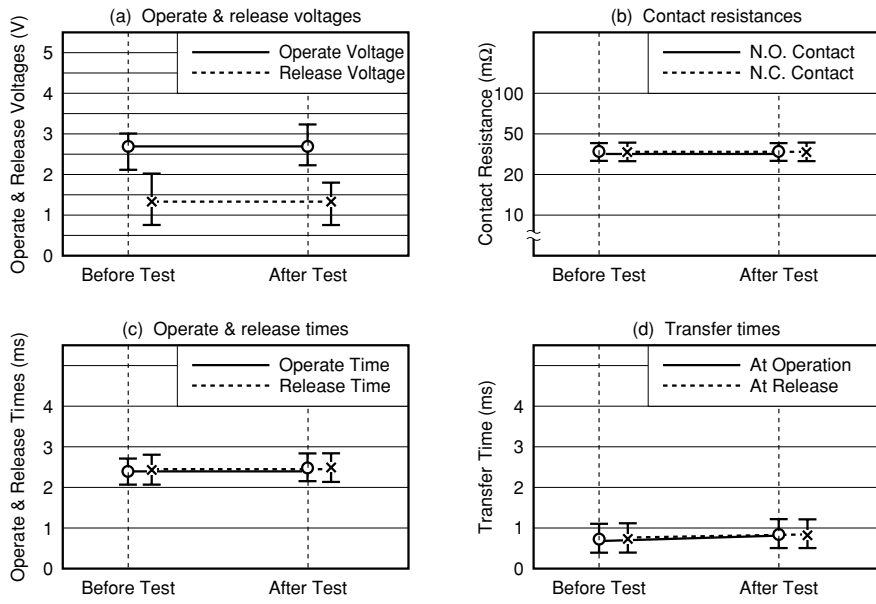

Figure 5.8 (2) Resistance to Reflow Solder Heat



- All specifications in this catalog and production status of products are subject to change without notice. Prior to the purchase, please contact EM Devices for updated product data.
- Please request for a specification sheet for detailed product data prior to the purchase.
- Before using the product in this catalog, please read "Precautions" and other safety precautions listed in the printed version catalog.

**5.1.9 Terminal strength test** (test conditions: ambient temperature: 25°C, tensile strength: 1.36 kg, 10 seconds bending: ±45°, 2 times, sample: 10 pcs. each)

The purpose of this test is to check whether the performance of the relay is degraded after an excessive force is applied to the terminals of the relay when the relay is mounted on a PCB.

**(1) Non-latching, 5-V type**

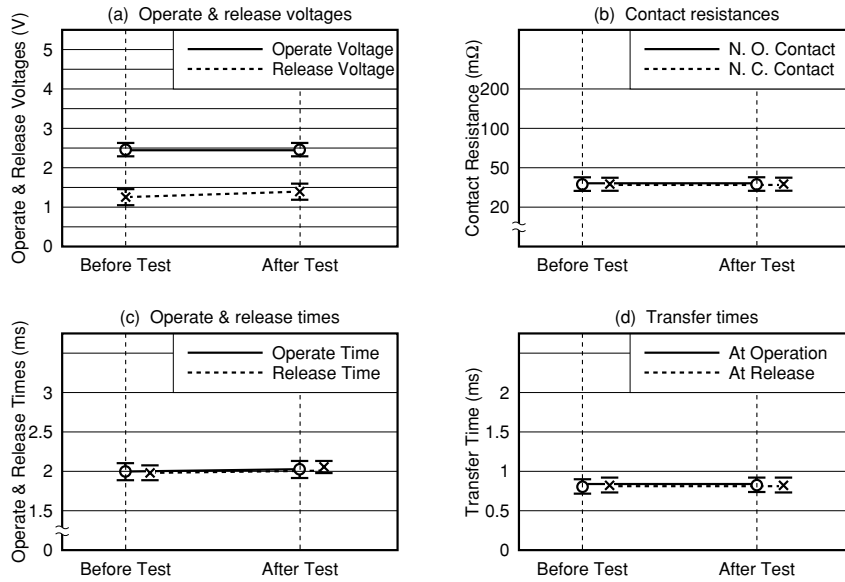

**Figure 5.9 Terminal Strength**



- All specifications in this catalog and production status of products are subject to change without notice. Prior to the purchase, please contact EM Devices for updated product data.
- Please request for a specification sheet for detailed product data prior to the purchase.
- Before using the product in this catalog, please read "Precautions" and other safety precautions listed in the printed version catalog.

## 5.2 Contact life tests

This section shows the results of tests conducted to examine the service life of the contacts, which has a significant influence on the life of the relay.

To test the service life of the contacts, the operate and release voltages, contact resistance, operate and release times, and transfer time of each relay is measured each time the relay has performed the specified number of operations under the specified conditions.

The service life of contacts of the ED2 series relay is equal to the one of the EF2 series relay, because they have common structure.

For changes in the characteristics, refer to the graphs shown below.

### 5.2.1 Non-load test (driving frequency: 50 Hz, ambient temperature: +25°C, sample: 10 non-latching types (rated at 5 V))

The cleanness of the contact surfaces influences the result of this test because no electric load is applied to the relay.

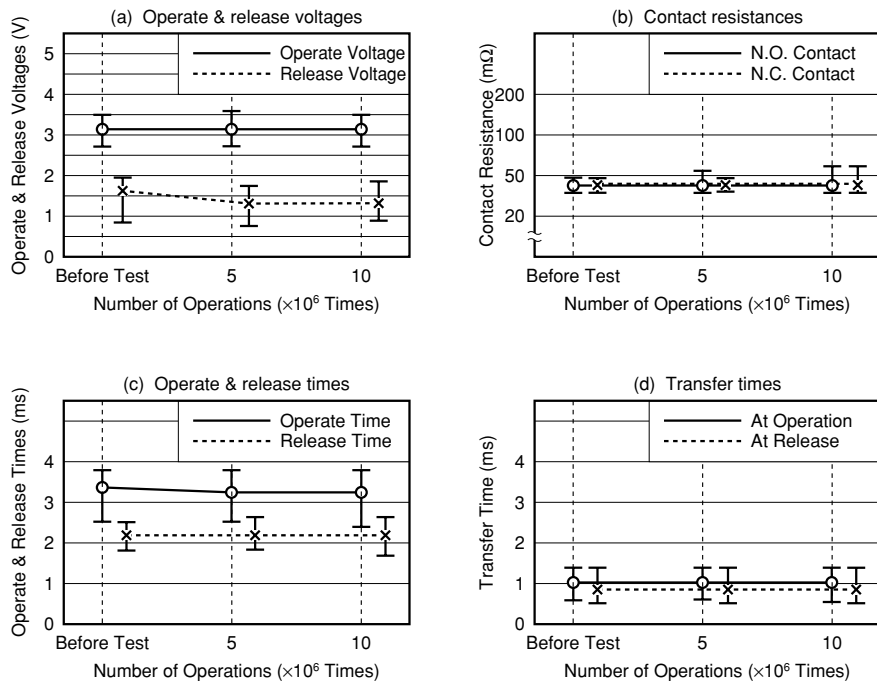

Figure 5.10 Non-load Test A



- All specifications in this catalog and production status of products are subject to change without notice. Prior to the purchase, please contact EM Devices for updated product data.
- Please request for a specification sheet for detailed product data prior to the purchase.
- Before using the product in this catalog, please read "Precautions" and other safety precautions listed in the printed version catalog.



**5.2.2 Resistive load test A** (contact load: 10 Vdc, 10 mA, resistive, driving frequency: 2 Hz, ambient temperature: +85°C, sample: 10 non-latching types (rated at 5 V))

This test is conducted with a load equivalent to the signal level of an IC applied to the relay.

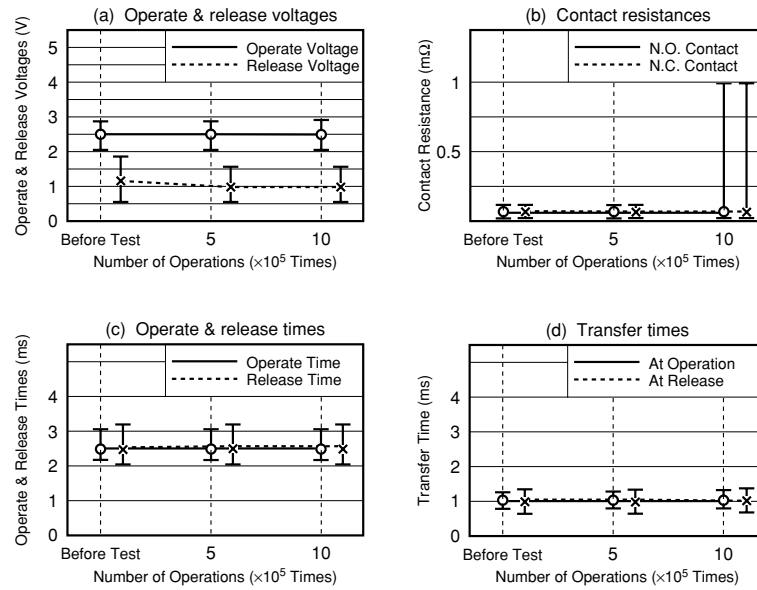

**Figure 5.11 Resistive Load Test B**

**5.2.3 Resistive load test B** (contact load: 50 Vdc, 100 mA, resistive, driving frequency: 5 Hz, ambient temperature: +85°C, sample: 10 non-latching types (rated at 5 V))

The load conditions of this test are equivalent to the voltage and current levels of a public telephone circuit.

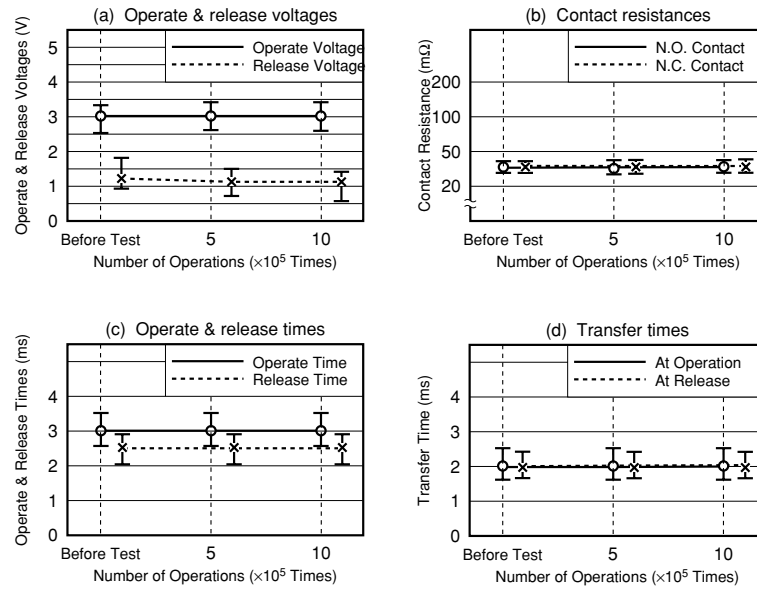

**Figure 5.16 Resistive Load Test E**



- All specifications in this catalog and production status of products are subject to change without notice. Prior to the purchase, please contact EM Devices for updated product data.
- Please request for a specification sheet for detailed product data prior to the purchase.
- Before using the product in this catalog, please read "Precautions" and other safety precautions listed in the printed version catalog.

**5.2.4 Resistive load test C** (contact load: 30 Vdc, 1 A, resistive, driving frequency: 1 Hz, ambient temperature: +25°C, sample: 10 non-latching types (rated at 5 V))

The load conditions of this test are at the maximum switching current and maximum switching power with the contacts switching a DC load.

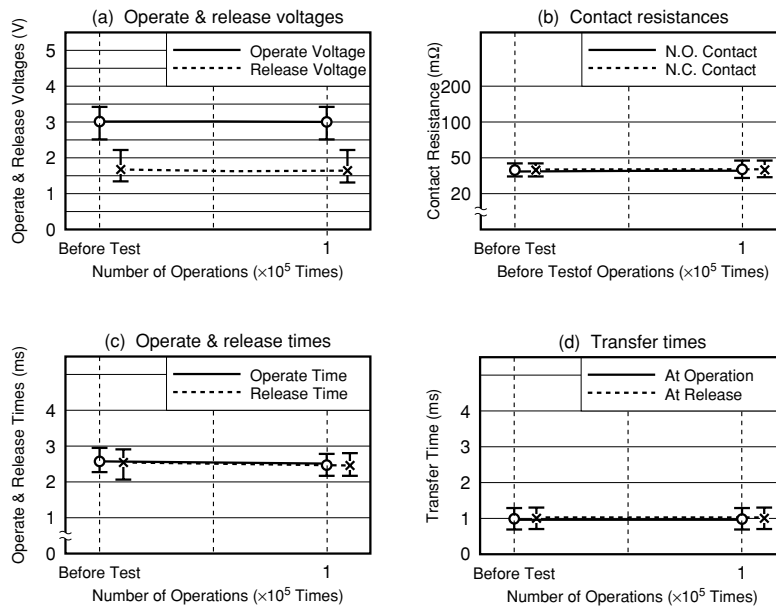

**Figure 5.13 Resistive Load Test H**



- All specifications in this catalog and production status of products are subject to change without notice. Prior to the purchase, please contact EM Devices for updated product data.
- Please request for a specification sheet for detailed product data prior to the purchase.
- Before using the product in this catalog, please read "Precautions" and other safety precautions listed in the printed version catalog.