

DATA SHEET

NEXEM

RoHS2 Compliant

MINIATURE SIGNAL RELAY

UC2/UD2 SERIES

SUPER-COMPACT SIZE, FLAT-PACKAGE

DESCRIPTION

NEXEM UC2/UD2 relay is a new generation miniature signal relay, super-compact and flat.

FEATURES

- Small mounting size of flat package for dense mounting
- Telcordia (2500 V) and FCC (1500 V) surge capacity
- IEC62368-1/ EN62368-1 spacing (Basic insulation class on 200 V working voltage)
- Low power consumption (100-140 mW)
- Moisture Barrier Bag (MBB) packaged UB2 relays meet moisture sensibility level (MSL) of IPC/JEDEC J-STD-020, ECA/IPC/JEDEC J-STD-075

APPLICATIONS

Test Equipment, Electronic switching systems, PBX, Terminal equipment, Telephone system

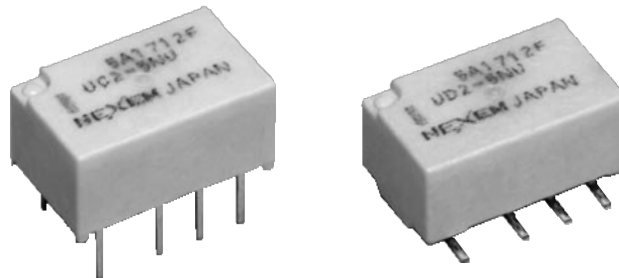

For Right Use of Miniature Relays

DO NOT EXCEED MAXIMUM RATINGS.

Do not use relays under exceeding conditions such as over ambient temperature, over voltage and over current. Incorrect use could result in abnormal heating, damage to related parts or cause burning.

READ CAUTIONS IN THE SELECTION GUIDE.

Read the cautions described in EM Devices' "Miniature Relays" when you choose relays for your application.

The information in this document is subject to change without notice.

© EM Devices Corporation 2026



- All specifications in this catalog and production status of products are subject to change without notice. Prior to the purchase, please contact EM Devices for updated product data.
- Please request for a specification sheet for detailed product data prior to the purchase.
- Before using the product in this catalog, please also read "NOTES ON CORRECT USE" in the selection guide

MARKINGS (Top view)

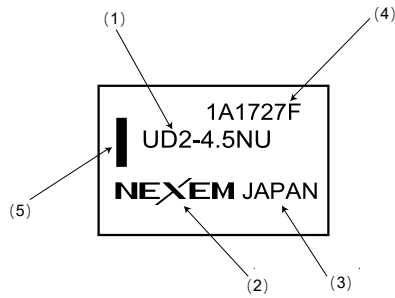

- (1) Part number
- (2) Manufacturer
- (3) Country of origin
- (4) Date code
- (5) Direction mark (pin No. 1 and 8)

DIMENSIONS

● **UC2 SERIES**

Unit: mm (inch)

DIMENSIONS

STANDARD / TRIMMED LEAD TYPE

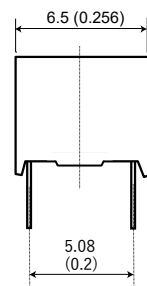
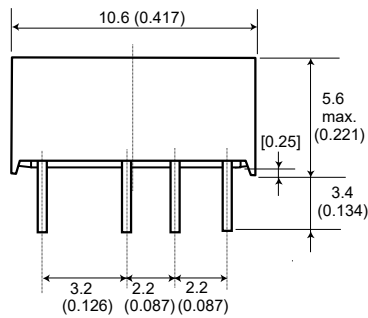

Tolerance of lead pitch is $\pm 0.15\text{mm}$ (0.006inch)
Other tolerances $\pm 0.3\text{mm}$ (0.012inch)

Lead size $0.4 \times 0.2 \pm 0.1$

Trimmed lead type: Lead length 2.8mm

PAD LAYOUTS (Bottom view)

[mm]

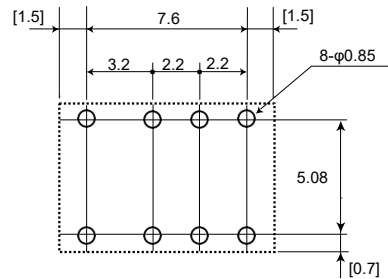

NOTE. General tolerance: ± 0.1

(Bottom view)

PIN CONFIGURATIONS (Bottom view)

Non-latch type

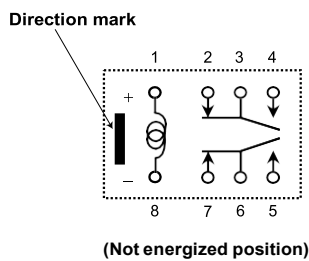

Single coil latch type

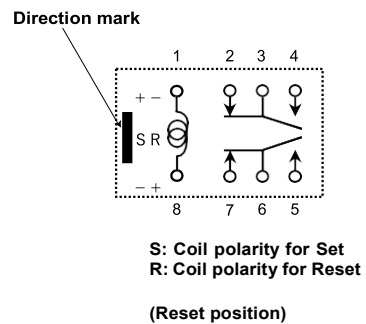

- All specifications in this catalog and production status of products are subject to change without notice. Prior to the purchase, please contact EM Devices for updated product data.
- Please request for a specification sheet for detailed product data prior to the purchase.
- Before using the product in this catalog, please also read "NOTES ON CORRECT USE" in the selection guide

● **UD2 SERIES**

Unit: mm (inch)

DIMENSIONS

STANDARD

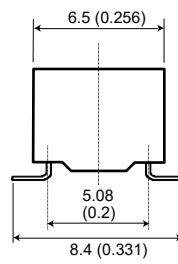
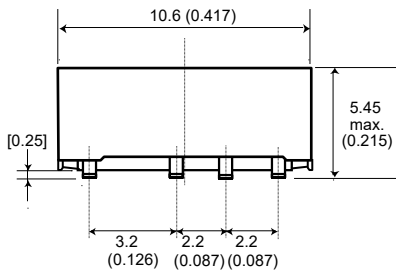

Tolerance of lead pitch is $\pm 0.15\text{mm}$ (0.006inch)
 Other tolerances $\pm 0.3\text{mm}$ (0.012inch)
 Coplanarity of terminals is 0.1mm max.

Lead size $0.4 \times 0.2 \pm 0.1$

PAD LAYOUTS (Top view)

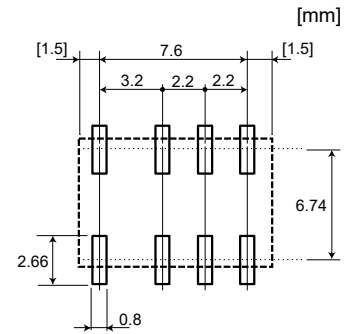

NOTE. General tolerance: ± 0.1

MINIMUM FOOTPRINT TYPE

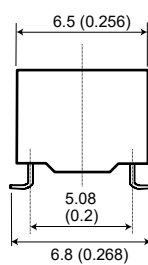
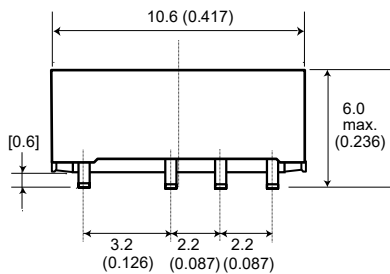

Tolerance of lead pitch is $\pm 0.15\text{mm}$ (0.006inch)
 Other tolerances $\pm 0.3\text{mm}$ (0.012inch)
 Coplanarity of terminals is 0.1mm max.

Lead size $0.4 \times 0.2 \pm 0.1$

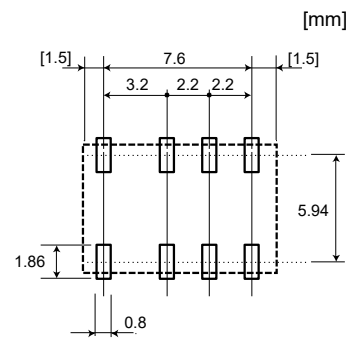

NOTE. General tolerance: ± 0.1

PIN CONFIGURATIONS (Top view)

Non-latch type

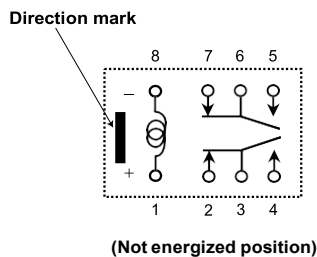

Single coil latch type

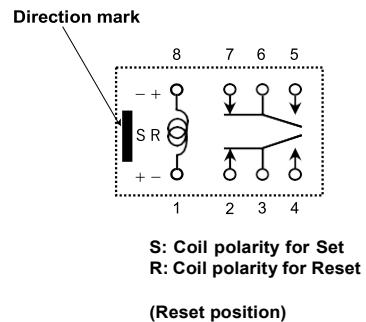

● All specifications in this catalog and production status of products are subject to change without notice. Prior to the purchase, please contact EM Devices for updated product data.
 ● Please request for a specification sheet for detailed product data prior to the purchase.
 ● Before using the product in this catalog, please also read "NOTES ON CORRECT USE" in the selection guide

GENERAL SPECIFICATIONS

Contact Form	2 Form C	
Contact Material	Silver alloy with gold alloy overlay	
Maximum Switching Power	30 W, 37.5 VA (resistive)	
Maximum Switching Voltage	220 Vdc, 250 Vac	
Maximum Switching Current	1 A	
Maximum Carrying Current	1 A	
Minimum Contact Ratings	10 m Vdc, 10 μ A *1	
Initial Contact Resistance	100 m Ω max.	
Operate Time [Set Time] (Excluding bounce)	Approx. 2 ms [2ms]	
Release Time [Reset Time] (Excluding bounce)	Approx. 1 ms [2ms] (Without diode)	
Insulation Resistance	1000 M Ω at 500 Vdc	
Withstanding Voltage	Between open contacts	1000 Vac (for one minute), 1500 V surge (10x160 μ s *2)
	Between adjacent contacts	1000 Vac (for one minute), 1500 V surge (10x160 μ s *2)
	Between coil and contacts	1800 Vac (for one minute), 2500 V surge (2x10 μ s *3)
Shock Resistance	735 m/s ² (75 G) (misoperation)	
	980 m/s ² (100 G) (destructive failure)	
Vibration Resistance	10 to 55 Hz, double amplitude 3 mm (196 m/s ²) (misoperation)	
	10 to 55 Hz, double amplitude 5 mm (294 m/s ²) (destructive failure)	
Ambient Temperature	-40 to +85 °C	
	-40 to +70 °C (Low power consumption type)	
Coil Temperature Rise	13 °C / 100mW, 18 °C / 140mW	
Running Specifications	Non-load	5x10 ⁷ operations (Non-latch type) *4 1x10 ⁷ operations (latch type)
	Load	30 Vdc 1 A (resistive), 1x10 ⁵ operations at 20 °C, 1 Hz
		125 Vac 0.3 A (resistive), 1x10 ⁵ operations at 20 °C, 1 Hz
Weight	Approx. 0.8 g	

* 1 This value is a reference value in the resistive load.

Minimum capacity changes depending on switching frequency and environment temperature and the load.

* 2 rise time: 10 μ s, decay time to half crest: 160 μ s

* 3 rise time: 2 μ s, decay time to half crest: 10 μ s

* 4 This shows the number of operations without fatal defects. Stable characteristics are maintained for 1 × 10⁷ operations.



●All specifications in this catalog and production status of products are subject to change without notice. Prior to the purchase, please contact EM Devices for updated product data.

●Please request for a specification sheet for detailed product data prior to the purchase.

●Before using the product in this catalog, please also read "NOTES ON CORRECT USE" in the selection guide

COIL SPECIFICATIONS

Non-latch Type at 20°C

Nominal Coil Voltage (Vdc)	Coil Resistance (Ω)±10%	Must Operate Voltage* (Vdc)	Must Release Voltage* (Vdc)	Nominal Operating Power (mW)
3	64.3	2.25	0.3	140
4.5	145	3.38	0.45	140
5	178	3.75	0.5	140
9	579	6.75	0.9	140
12	1028	9.0	1.2	140

Single Coil Latch Type at 20°C

Nominal Coil Voltage (Vdc)	Coil Resistance (Ω)±10%	Must Set Voltage* (Vdc)	Must Reset Voltage* (Vdc)	Nominal Operating Power (mW)
3	90	2.25	2.25	100
4.5	202.5	3.38	3.38	100
5	250	3.75	3.75	100
9	810	6.75	6.75	100

Note: Apply the coil voltage so that the No.1 pin is on the + side when set and the No.8 pin is on the + side when reset.

Non-latch Low Power Consumption Type at 20°C

Nominal Coil Voltage (Vdc)	Coil Resistance (Ω)±10%	Must Operate Voltage* (Vdc)	Must Release Voltage* (Vdc)	Nominal Operating Power (mW)
3	90	2.4	0.3	100
4.5	202.5	3.6	0.45	100
5	250	4.0	0.5	100

Note: * Test by pulse voltage

SAFETY STANDARD AND RATING

UL Recognized (UL508) * File No E73266	CSA Certified (CSA C22.2 No14) ** File No LR46266
30 Vdc, 1 A (Resistive) 110 Vdc, 0.3 A (Resistive) 125 Vac, 0.5 A (Resistive)	

* Spacing: UL840, **Spacing: CSA std950

TUV Certificate (EN61810-1)
No. R2050596
Creepage and clearance of coil to contact is more than 2 mm. (According to EN62368-1)
Basic insulation class

RECOMMENDED RELAY DRIVE CONDITIONS

Drive under conditions.

Non-latch type	Voltage: within ±5% of nominal voltage	Ambient temperature - 40 to +85 °C
Non-latch type (Low power consumption Type)		Ambient temperature - 40 to +70 °C
Single coil latch type	Square pulse (rise and fall time is rapid) pulse height: within ±5% of nominal voltage pulse width: more than 10 ms	Ambient temperature - 40 to +85 °C



●All specifications in this catalog and production status of products are subject to change without notice. Prior to the purchase, please contact EM Devices for updated product data.
 ●Please request for a specification sheet for detailed product data prior to the purchase.
 ●Before using the product in this catalog, please also read "NOTES ON CORRECT USE" in the selection guide

PART NUMBER SYSTEM

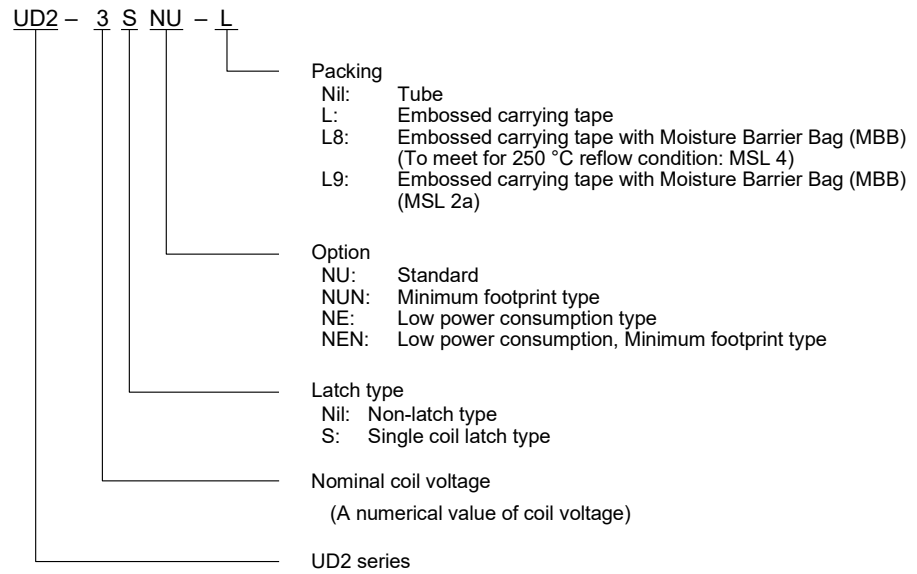
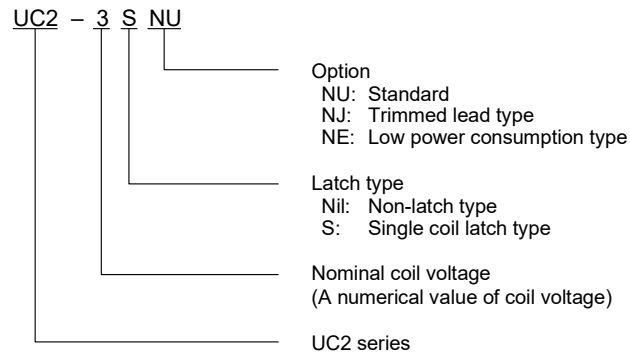

ORDERING PART NUMBERS

□ UC2 series

Option		Nominal Coil Voltage (Vdc)	Coil Type		
Terminal	Packing		Non-latch	Single Coil Latch	Non-latch Low power consumption
Standard	Tube	3	UC2-3NU	UC2-3SNU	UC2-3NE
		4.5	UC2-4.5NU	UC2-4.5SNU	UC2-4.5NE
		5	UC2-5NU	UC2-5SNU	UC2-5NE
		9	UC2-9NU	UC2-9SNU	-
		12	UC2-12NU	-	-
Trimmed lead		3	UC2-3NJ	UC2-3SNJ	-
		4.5	UC2-4.5NJ	UC2-4.5SNJ	-
		5	UC2-5NJ	UC2-5SNJ	-
		9	UC2-9NJ	UC2-9SNJ	-
		12	UC2-12NJ	-	-



●All specifications in this catalog and production status of products are subject to change without notice. Prior to the purchase, please contact EM Devices for updated product data.
 ●Please request for a specification sheet for detailed product data prior to the purchase.
 ●Before using the product in this catalog, please also read "NOTES ON CORRECT USE" in the selection guide

□ UD2 series

Option		Nominal Coil Voltage (Vdc)	Coil Type		
Terminal	Packing		Non-latch	Single Coil Latch	Non-latch Low power consumption
Standard	Tube	3	UD2-3NU	UD2-3SNU	UD2-3NE
		4.5	UD2-4.5NU	UD2-4.5SNU	UD2-4.5NE
		5	UD2-5NU	UD2-5SNU	UD2-5NE
		9	UD2-9NU	UD2-9SNU	-
		12	UD2-12NU	-	-
	Taping	3	UD2-3NU-L	UD2-3SNU-L	UD2-3NE-L
		4.5	UD2-4.5NU-L	UD2-4.5SNU-L	UD2-4.5NE-L
		5	UD2-5NU-L	UD2-5SNU-L	UD2-5NE-L
		9	UD2-9NU-L	UD2-9SNU-L	-
		12	UD2-12NU-L	-	-
	Taping (MBB)	3	UD2-3NU-L8	UD2-3SNU-L8	UD2-3NE-L9
		4.5	UD2-4.5NU-L8	UD2-4.5SNU-L8	UD2-4.5NE-L9
		5	UD2-5NU-L8	UD2-5SNU-L8	UD2-5NE-L9
		9	UD2-9NU-L8	UD2-9SNU-L8	-
		12	UD2-12NU-L8	-	-
Minimum footprint	Tube	3	UD2-3NUN	UD2-3SNUN	UD2-3NEN
		4.5	UD2-4.5NUN	UD2-4.5SNUN	UD2-4.5NEN
		5	UD2-5NUN	UD2-5SNUN	UD2-5NEN
		9	UD2-9NUN	UD2-9SNUN	-
		12	UD2-12NUN	-	-
	Taping	3	UD2-3NUN-L	UD2-3SNUN-L	UD2-3NEN-L
		4.5	UD2-4.5NUN-L	UD2-4.5SNUN-L	UD2-4.5NEN-L
		5	UD2-5NUN-L	UD2-5SNUN-L	UD2-5NEN-L
		9	UD2-9NUN-L	UD2-9SNUN-L	-
		12	UD2-12NUN-L	-	-
	Taping (MBB)	3	UD2-3NUN-L8	UD2-3SNUN-L8	UD2-3NEN-L9
		4.5	UD2-4.5NUN-L8	UD2-4.5SNUN-L8	UD2-4.5NEN-L9
		5	UD2-5NUN-L8	UD2-5SNUN-L8	UD2-5NEN-L9
		9	UD2-9NUN-L8	UD2-9SNUN-L8	-
		12	UD2-12NUN-L8	-	-

Note:

1. Only MBB packaging part numbers meet MSL (L8: MSL 4, L9: MSL 2a). However, it does not fully conform to JEDEC standards. Please note that part numbers other without MBB packaging do not meet MSL.
2. Low power consumption type does not support 250°C peak reflow condition.



- All specifications in this catalog and production status of products are subject to change without notice. Prior to the purchase, please contact EM Devices for updated product data.
- Please request for a specification sheet for detailed product data prior to the purchase.
- Before using the product in this catalog, please also read "NOTES ON CORRECT USE" in the selection guide

PERFORMANCE DATA

COIL TEMPERATURE RISE

Temperature is measured by coil resistance.

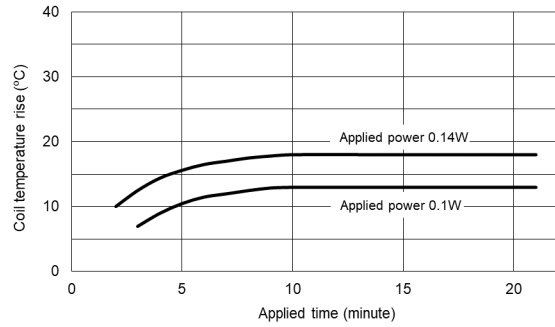
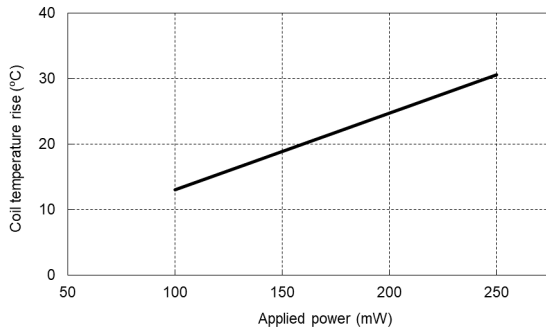

SWITCHING CAPACITY

This is allowed maximum value.

Inquire with EM Devices for maximum value under continuous use.

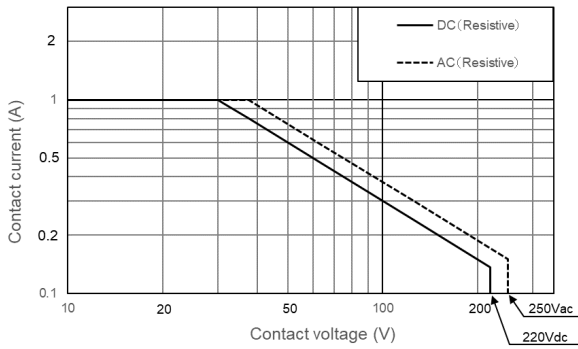

MAXIMUM COIL VOLTAGE

This is a maximum value of permissible alteration.

Inquire with EM Devices under continuous use.

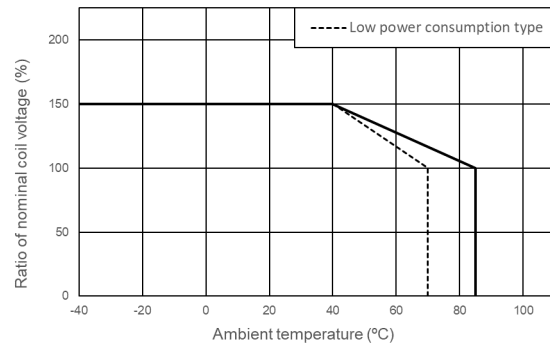

APPLIED POWER VS. TIMING (Sample: UC2-5NU)

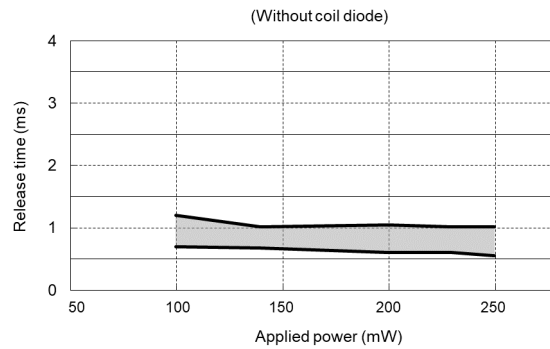
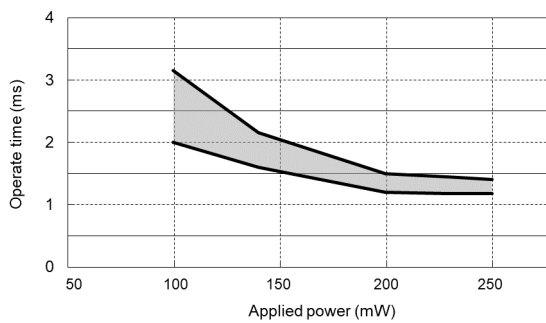

● All specifications in this catalog and production status of products are subject to change without notice. Prior to the purchase, please contact EM Devices for updated product data.
 ● Please request for a specification sheet for detailed product data prior to the purchase.
 ● Before using the product in this catalog, please also read "NOTES ON CORRECT USE" in the selection guide

□ OPERATE AND RELEASE VOLTAGE VS. AMBIENT TEMPERATURE

This shows a typical change of operate (release) voltage. The value of must operate is estimated, so coil voltage must be applied more than this value for safety operation. For hot start operation, please inquire with EM Devices.

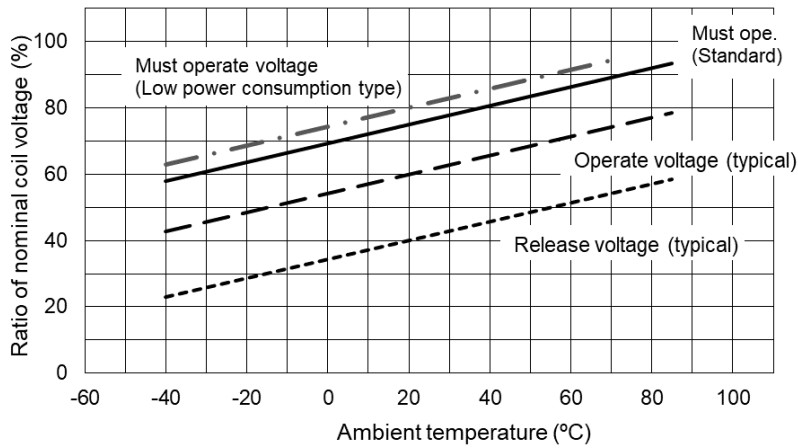

□ RUNNING TEST (Non-load)

(Load: none, Drive: 5Vdc, 50Hz, 50% duty, Ambient temperature: room temperature, Sample: UC2-5NU, 20pieces)

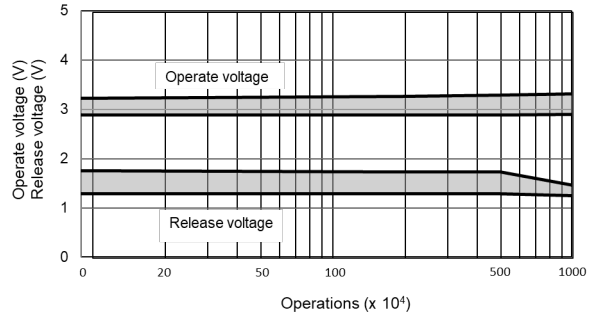
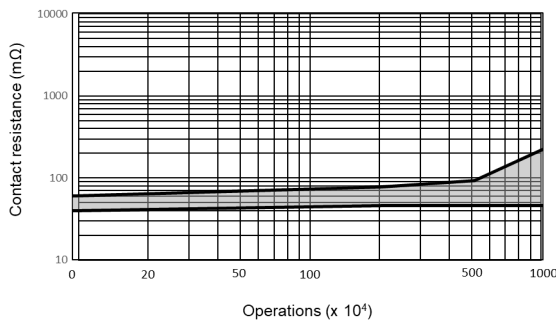

□ RUNNING TEST (Load)

(Load: 50Vdc 0.1A resistive, Drive: 5Vdc, 5Hz, 50% duty, Ambient temperature: 85°C, Sample: UC2-5NU, 10pieces)

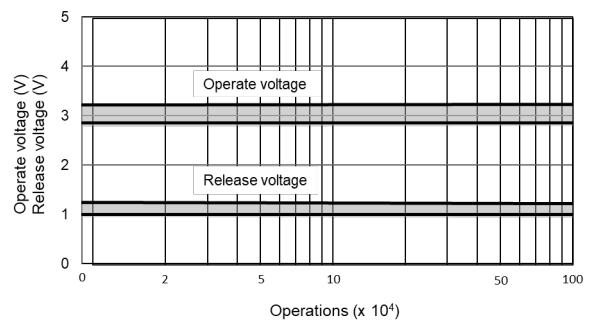
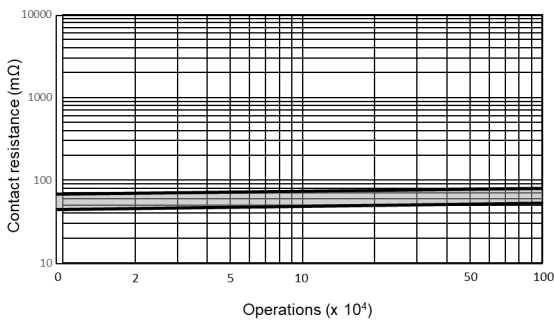

● All specifications in this catalog and production status of products are subject to change without notice. Prior to the purchase, please contact EM Devices for updated product data.
 ● Please request for a specification sheet for detailed product data prior to the purchase.
 ● Before using the product in this catalog, please also read "NOTES ON CORRECT USE" in the selection guide

□ BREAKDOWN VOLTAGE

Sample: UC2-5NU 10pieces

(a) Between open contacts

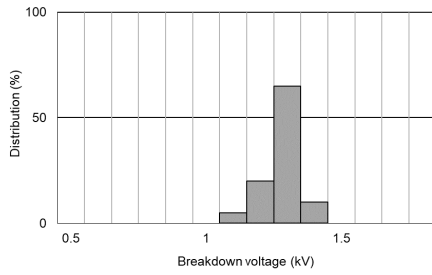

(b) Between adjacent contacts

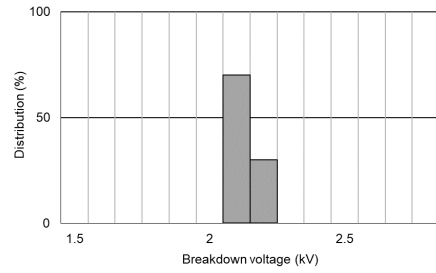

(c) Between coil and contacts

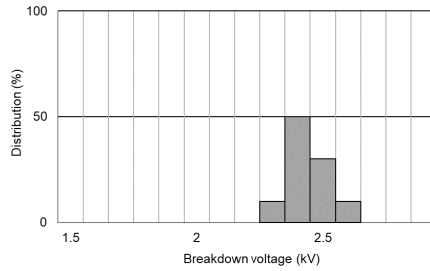

Note: Applying 2.8 kVac or more may cause of breakdown outside U series relay (between terminals).

□ ALTERNATION OF VOLTAGE AT DENSELY MOUNTING (Magnet interference)

Alternation of operate voltage

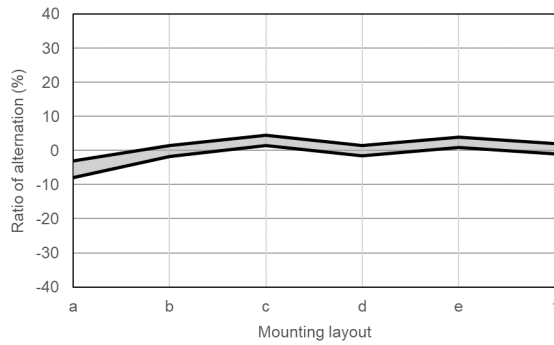

Alternation of release voltage

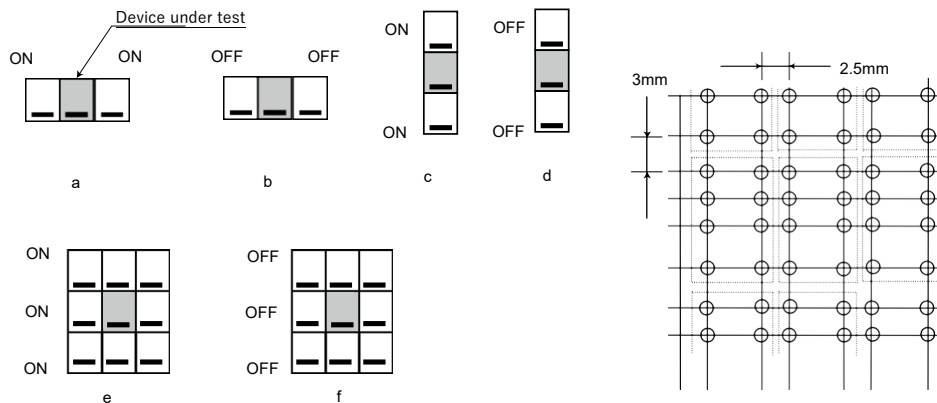
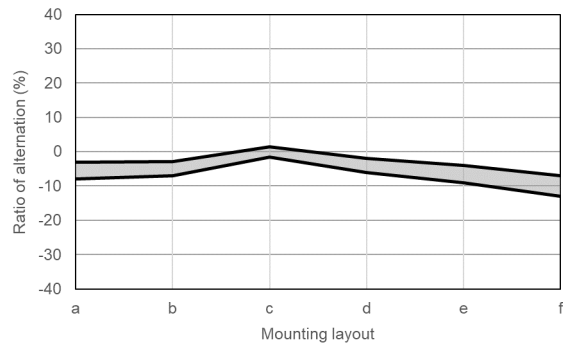

- All specifications in this catalog and production status of products are subject to change without notice. Prior to the purchase, please contact EM Devices for updated product data.
- Please request for a specification sheet for detailed product data prior to the purchase.
- Before using the product in this catalog, please also read "NOTES ON CORRECT USE" in the selection guide

PACKING DIMENSIONS

(Unit: mm)

TUBE PACKING (UC2/UD2)

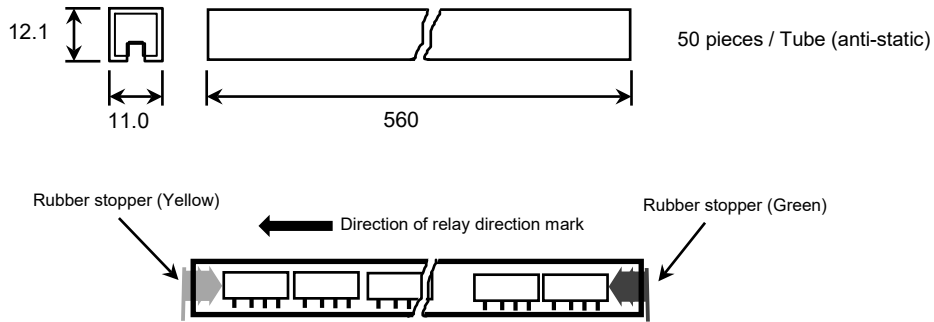

TAPE PACKING (UD2)

APPEARANCE

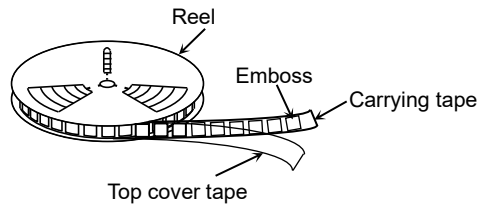

Reel material: Corrugated Cardboard (L)
 PS (L8, L9 : MBB)
 Relay quantity: 1200 pieces / Reel (L)
 1100 pieces / Reel (L8, L9 : MBB)
 *Two reels are sealed in one MBB.
 Reel diameter: 380mm

TAPE DIMENSIONS

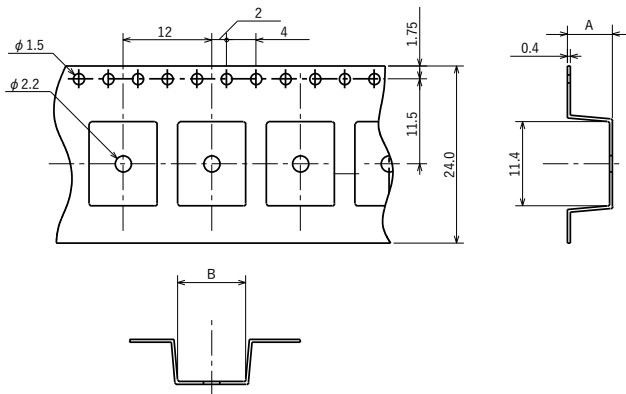

	A	B
UD2- X XNU-L X	Max. 6.2	9.2
UD2- X XNE-L X		
UD2- X XNUN-L X	Max. 6.6	7.5
UD2- X XNEN-L X		

RELAY DIRECTION AND TAPE CARRYING DIRECTION

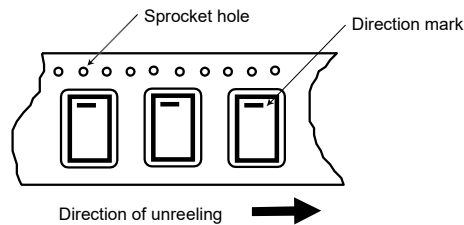

●All specifications in this catalog and production status of products are subject to change without notice. Prior to the purchase, please contact EM Devices for updated product data.
 ●Please request for a specification sheet for detailed product data prior to the purchase.
 ●Before using the product in this catalog, please also read "NOTES ON CORRECT USE" in the selection guide

SOLDERING TEMPERATURE CONDITION

THROUGH-HOLE MOUNTING (UC2)

1. Automatic soldering

Preheating (Terminal): 110~ 120°C / 110s. max.
 Solder temperature: 260°C max.
 Soldering time: 5s max.

Note: EM Devices recommends cooling down a printed circuit board less than 110°C within 40s after soldering.
 The above are flow soldering conditions. Check the actual soldering condition to use other automatic soldering methods.

2. Manual soldering (by soldering iron)

Soldering temperature (Tip): 350°C max.
 Soldering time: 3 s max.

Note: Heating of this product by automatic soldering and manual soldering is limited to a total of three times.

SURFACE-MOUNTING TYPE (UD2)

1. Reflow Method (NEXEM recommend profile)

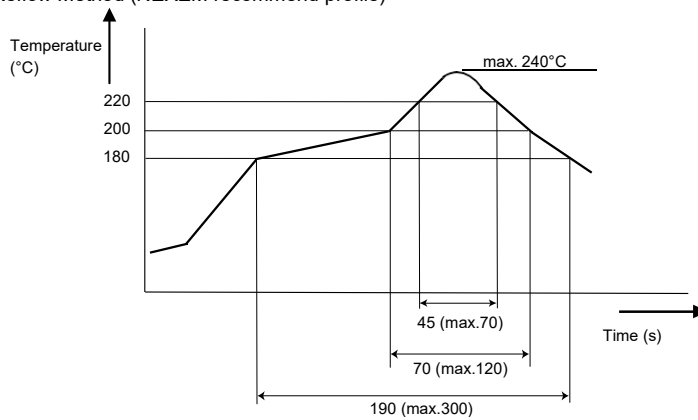

*Temperature profile shows printed circuit board surface temperature on the relay terminal portion.

2. Reflow Method (JEDEC compliant profile)

*Product name only to meet for 250 °C reflow condition (L8 packaging)

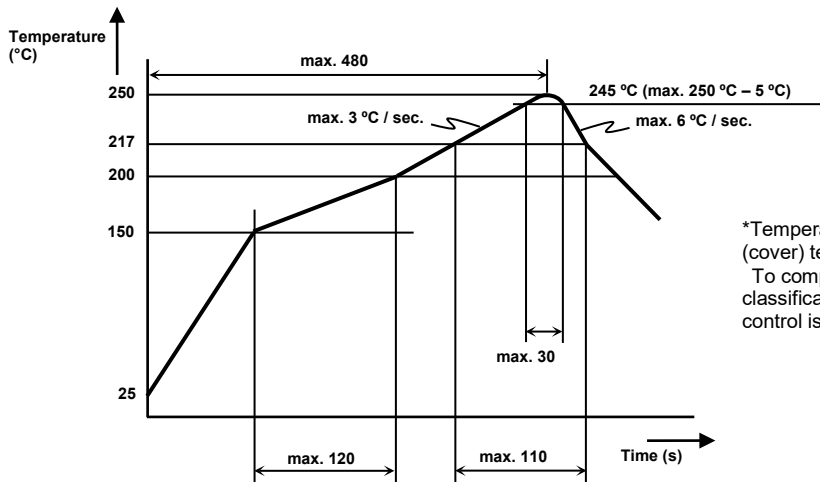

*Temperature profile shows body (cover) temperature.
 To comply with this 250°C classification temperature, MSL 4 control is absolutely necessary.

Note:

1. Heating by reflow should be limited to two times. However, allow sufficient time for cooling of the product between the first and second reflow.
2. Check the actual soldering condition to use other method except above mentioned temperature profiles.



●All specifications in this catalog and production status of products are subject to change without notice. Prior to the purchase, please contact EM Devices for updated product data.
 ●Please request for a specification sheet for detailed product data prior to the purchase.
 ●Before using the product in this catalog, please also read "NOTES ON CORRECT USE" in the selection guide

NOTE ON CORRECT USE

1. Notes on contact load

Make sure that the contact load is within the specified range; otherwise, the lifetime of the contacts will be shortened considerably.

Note that the running performance shown is an example, and that it varies depending on parameters such as the type of load, switching frequency, driver circuit, and ambient temperature under the actual operating conditions. Evaluate the performance by using the actual circuit before using the relay.

2. Driving relays

- If the internal connection diagram of a relay shows + and - symbols on the coil, apply the rated voltage to the relay in the specified direction. If a rippled DC current source is used, abnormalities such as beat at the coil may occur.
- The maximum voltage that can be applied to the coil of the relay varies depending on the ambient temperature. Generally, the higher the voltage applied to the coil, the shorter the operating time. Note, however, that a high voltage also increases the bounce of the contacts and the contact opening and closing frequency, which may shorten the lifetime of the contacts.
- If the driving voltage waveform of the relay coil rises and falls gradually, the inherent performance of the relay may not be fully realized. Make sure that the voltage waveform instantaneously rises and falls as a pulse.

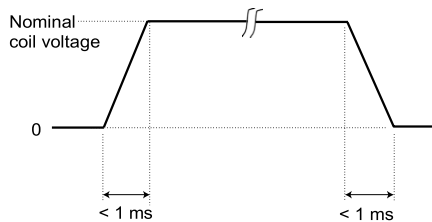

- For a latching relay, apply a voltage to the coil according to the polarity specified in the internal connection diagram of the relay.
- If a current is applied to the coil over a long period of time, the coil temperature rises, promoting generation of organic gas inside the relay, which may result in faulty contacts. In this case, use of a latching relay is recommended.
- The operating time and release time indicate the time required for each contact to close after the voltage has been applied to or removed from the coil. However, because the relay has a mechanical structure, a bounce state exists at the end of the operating and release times. Furthermore, because additional time is required until the contact stabilizes after being in a high-resistance state, care must be taken when using the relay at high speeds.

3. Operating environment

- Make sure that the relay mounted in the application set is used within the specified temperature range. Use of a relay at a temperature outside this range may adversely affect insulation or contact performance.

- If the relay is used for a long period of time in highly humid (RH 85% or higher) environment, moisture may be absorbed into the relay. This moisture may react with the NOx and SOx generated by glow discharges that occur when the contacts are opened or closed, producing nitric or sulfuric acid. If this happens, the acid produced may corrode the metallic parts of the relay, causing operational malfunction.
- If any material containing silicone (silicone rubber, silicone oil, and silicone-based coating material) is used in the neighborhood of relay, there is some possibility that these materials will emit silicone gas that will penetrate the relay. In this case, the switching contact may generate silicone on the surface of contacts. This silicone may result in contact failure. Avoid use of relay in such an environment.
- Because the operating temperature range varies depending on the humidity, use the relay in the temperature range illustrated in the figure below. Prevent the relay from being frozen and avoid the generation of condensation.

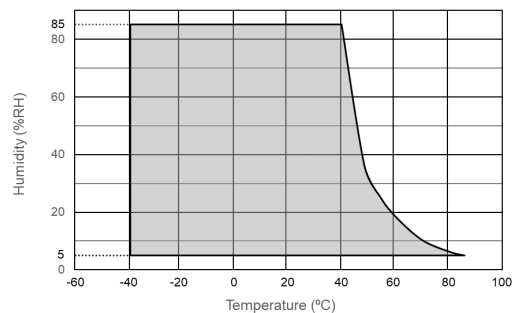

- The same applies when the relay is stored or transported. Keep the upper-limit value of the temperature to which the relay is exposed after it is removed from the carton box to within 50°C. Please also refer to "5. Handling" for SMT relays.
- Permanent magnets are used in polarized relays. For this reason, when magnets, transformers, or speakers are located nearby the relay characteristics may change and faulty operations may result.
- The relay maintains constant sealability under normal atmospheric pressure (810 to 1,200 hPa). Its sealability may be degraded or the relay may be deformed and malfunction if it is used under barometric conditions exceeding the specified range. Avoid using vacuum oven during baking or drying cleaning solutions.
- If excessive vibration or shock is applied to the relay, it may malfunction, and the contacts remain closed. Vibration or shock applied to the relay during operation may cause considerable damage to or wearing of the contacts. Note that operation of a snap switch mounted close to the relay or shock due to the operation of magnetic solenoid may also cause malfunctioning.



●All specifications in this catalog and production status of products are subject to change without notice. Prior to the purchase, please contact EM Devices for updated product data.
 ●Please request for a specification sheet for detailed product data prior to the purchase.
 ●Before using the product in this catalog, please also read "NOTES ON CORRECT USE" in the selection guide

4. Notes on mounting relays

- When mounting a relay onto a PC board using an automatic chip mounter, if excessive force is applied to the cover of the relay when the relay is chucked or inserted, the cover may be damaged, or the characteristics of the relay degraded. Keep the force applied to the relay to within 1 kg.
- Avoid bending the pins to temporarily secure the relay to the PC board. Bending the pins may degrade sealability or adversely affect the internal mechanism.
- It is recommended to solder the relay onto a PC board under the following conditions:

<1> Reflow soldering

Refer to the recommended soldering temperature profile. Please note that excessive heating beyond the specified peak temperature or heating time will damage the airtightness.

<2> Flow soldering

Solder temperature: 260°C max., Time: 5s max.
 Preheating (Terminals): 110~120°C / 110s. (max.)
 EM Devices recommends cooling down a printed circuit board less than 110°C within 40 seconds after soldering.

<3> Manual soldering

Soldering temperature (Tip): 350°C, Time: 3s max.
 Avoid immersing the relay in cleaning solvent immediately after soldering due to the danger of thermal shock being applied to the relay.

- Use an alcohol-based or water-based cleaning solvent. Never use thinner and benzene because they may damage the relay housing.
- Do not use ultrasonic cleaning because the vibration energy generated by the ultrasonic waves may cause the contacts to remain closed.
- When using a vacuum oven to dry the cleaning solution, the relay's seal-ability may be compromised. Avoid drying conditions lower than normal atmospheric pressure.

5. Handling

- Relays are packaged in magazine cases for shipment. If a space is created in the case after some relays have been removed, be sure to insert a stopper to secure the remaining relays in the case. If relays are not well secured, vibration during transportation may cause malfunctioning of the contacts.
- Exercise care in handling the relay so as to avoid dropping it or allowing it to fall. Do not use a relay that has been dropped. If a relay drops from a workbench to the floor, a shock of 9,800 m/s² (1,000 G) or more is applied to the relay, possibly damaging its functions. Even if a light shock has been applied to the relay, thoroughly evaluate its operation before using it.
- Latching relays are factory-set to the reset state for shipment. A latching relay may be set, however, by vibration or shock applied while being transported. Be sure to forcibly reset the relay before using it in the application set. Also note that the relay may be set by unexpected vibration or shock when it is used in a portable set.

- The sealability of a surface mount type (SMT) relay may be lost if the relay absorbs moisture and is then heated during soldering. When storing relays, therefore, observe the following points:

<1> For standard packing

(a). Pack state

Term: Less than 12 months after our shipment.
 (Recommend using the product within 3 months if possible.)

Conditions: <30 °C, <60% RH

(b). Require bake before mounting, when relays not used within the above (a) period or was stored outside above (a) conditions.

Simple relay: Please dehumidify 85 ± 5 °C, 48 hours or more after transferring to a heat-resistant container.

Tape packing: Please dehumidify 50 ± 5 °C, 300 hours or more in reel condition.

Tube packaging should be baking on simple relays, removed from tube.

Relays after baking should be mounted within 3 months under the conditions in (a).

Standard packaging specification products do not meet with the JEDEC standard's Moisture Sensitivity Level (MSL) because they are not MBB packaged. If MSL compliance is required, use MBB packaging specification products.

<2> For MBB packing

(a). MBB state

Term: Less than 12 months after our shipment

Conditions: <30 °C, <60% RH

(b). After opening of MBB

Term: Within the time limit indicated on the caution label attached to MBB.

Conditions: <30 °C, <60% RH

(c). Require bake before mounting, when relays not used within the above (a) or (b) period or was stored outside above conditions.

Simple relay: Please dehumidify 85 ± 5 °C, 48 hours or more after transferring to a heat-resistant container.

Tape packing: Please dehumidify 50 ± 5 °C, 300 hours or more in reel condition. Please keep in mind that barrier pack needs to remove in that case.

Relays after baking should be mounted within the time limits according to MSL on the caution label under the conditions in (b).

The humidity indicator card included in MBB package immediately after opening should also be used as a basis for judging baking procedures.



●All specifications in this catalog and production status of products are subject to change without notice. Prior to the purchase, please contact EM Devices for updated product data.
 ●Please request for a specification sheet for detailed product data prior to the purchase.
 ●Before using the product in this catalog, please also read "NOTES ON CORRECT USE" in the selection guide

No part of this document may be copied or reproduced in any form or by any means without the prior written consent of EM Devices Corporation. EM Devices Corporation assumes no responsibility for any errors which may appear in this document.

EM Devices Corporation does not assume any liability for infringement of patents, copyrights or other intellectual property rights of third parties by or arising from use of a device described herein or any other liability arising from use of such device. No license, either express, implied or otherwise, is granted under any patents, copyrights or other intellectual property rights of EM Devices Corporation or others.

While EM Devices Corporation has been making continuous effort to enhance the reliability of its electronic components, the possibility of defects cannot be eliminated entirely. To minimize risks of damage or injury to persons or property arising from a defect in an EM Devices electronic component, customers must incorporate sufficient safety measures in its design, such as redundancy, fire-containment, and anti-failure features.

EM Devices' products are classified into the following three quality grades: "Standard," "Special," and "Specific". The Specific quality grade applies only to devices developed based on a customer designated "quality assurance program" for a specific application. The recommended applications of a device depend on its quality grade, as indicated below. Customers must check the quality grade of each device before using it in a particular application. If customers intend to use EM Devices' products for applications other than those specified for Standard quality grade, they should contact an EM Devices sales representative in advance, as specifications must be exchanged with EM Devices.

Standard: Computers, office equipment, communications equipment, test and measurement equipment, audio and visual equipment, home electronic appliances, machine tools, personal electronic equipment and industrial robots

Special: Transportation equipment (automobiles, trains, ships, etc.), traffic control systems, anti-disaster systems, anti-crime systems, safety equipment and medical equipment (not specifically designed for life support)

Specific: Aircrafts, aerospace equipment, submersible repeaters, nuclear reactor control systems, life support systems or medical equipment for life support, etc.

The quality grade of EM Devices' products is "Standard" unless otherwise specified in EM Devices' Data Sheets or Data Books. EM Devices cannot guarantee the quality of our products if the product is used for applications other than "Standard" applications without exchanging specifications with EM Devices, or if the product is used for "Standard" applications under conditions or in environments not described in this document.

(Note)

The information in this document is subject to change without notice. Please refer to the latest data sheet when designing for mass production.



- All specifications in this catalog and production status of products are subject to change without notice. Prior to the purchase, please contact EM Devices for updated product data.
- Please request for a specification sheet for detailed product data prior to the purchase.
- Before using the product in this catalog, please also read "NOTES ON CORRECT USE" in the selection guide